



Main Catalog Dental



Competence in Instruments
MADE IN GERMANY

02	SCALPELS AND <i>PERIOTOMES</i>	P.	5-7
03	SCISSORS	P.	8-14
04	TC SCISSORS	P.	15-16
05	MICRO SCISSORS	P.	17-18
08	DISSECTING AND TISSUE <i>FORCEPS</i>	P.	19-23
09	MICRO AND ATRAUMATIC <i>FORCEPS</i>	P.	24-27
10	COLLEGE <i>FORCEPS</i> AND <i>MEASURING INSTRUMENTS</i>	P.	28-33
13	HEMOSTATIC <i>FORCEPS</i>	P.	34-37
17	AUXILLARY <i>CLAMPS</i> AND <i>FORCEPS</i>	P.	38-41
19	NEEDLE <i>HOLDER</i>	P.	42-43
20	TC <i>NEEDLE HOLDER</i>	P.	44-53
24	RETRACTORS	P.	54-66
27	ELEVATORS AND <i>RASPATORIES</i>	P.	67-73

31	<i>BONE RONGEURS</i>	P.	74-76
42	<i>MEASURING DEVICES</i>	P.	77-78
46	<i>SINUS CURETTES</i>	P.	79-82
48	<i>MOUTH WEDGER, GAGS, DEPRESSORS</i>	P.	83-88
67	<i>BONE PREP INSTRUMENTS AND TOOLS</i>	P.	89-102
68	<i>HARD AND SOFT TISSUE AUGMENTATION SCREWS AND PINS</i>	P.	103-111
73	<i>ORGANIZATION AND STORAGE</i>	P.	112-115
79	<i>CLEANING AND CARE</i>	P.	116
80	<i>EXTRACTING FORCEPS ENGLISH PATTERN</i>	P.	117-132
81	<i>EXTRACTING FORCEPS WITH ANATOMICALLY SHAPED HANDLE</i>	P.	133-139
83	<i>ROOT ELEVATORS</i>	P.	140-151
84	<i>BASIC INSTRUMENTS, MOUTH MIRRORS AND SYRINGES</i>	P.	152-159
85	<i>PERIODONTICS</i>	P.	160-172

86	<i>HAND INSTRUMENTS</i>	P.	173-182
87	<i>PROSTHETICS & ROOF RESECTION</i>	P.	183-188
88	<i>IMPRESSION TRAYS</i>	P.	189-191
89	<i>PROSTHETICS</i>	P.	192-197
90	<i>STORAGE, ORGANISATION AND STERILIZATION</i>	P.	198-206
91	<i>INSTRUMENT SETS</i>	P.	207-223

02

SCALPELS AND PERIOTOMES



02

Standard Scalpels and Blades

Blades, sterile, 100pcs.



02-040-011
Size



02-040-012
Size 12



02-040-015
Size 15



02-040-124
Size 12D



02-040-153
Size 15C



1/1



1/1



1/1



02-030-030

Scalpel Handle,
No. 3
125mm

02-030-070

Scalpel Handle,
No. 7

02-030-150 G

Scalpel Handle, 15
cm, round shaped,
smooth

02-046-022

BLADE BUTLER, for
removing scalpel
blades from handle

Micro Blades, sterile, 25pcs.



02-044-063
Size 63



02-044-067
Size 67



02-044-069
Size 69



1/1

02-038-140

Micro-Scalpel Handle, 14 cm,
anatomical shape



1/1

02-795-000POT3

Periotome, size 1, straight,
complete, peek handle



1/1

02-796-000POT3

Periotome, size 1, straight,
complete, peek handle

03

SCISSORS



REYNOLDS



03-155-145

14.5cm, delicate, curved

METZENBAUM



03-071-145

14.5cm, curved

JAMESON



03-185-155

15.5cm, delicate, curved

KILNER



03-449-120

12cm, delicate, curved



03-081-145

14.5cm, delicate, curved



03-081-145 SC

14.5cm, delicate, curved, Super-Cut

03

Suture & Gum Scissors

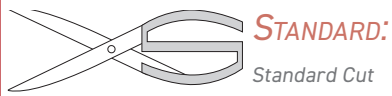

STANDARD:
Standard Cut



SUPERCUT (SC):

Special Cut with tothing in one scissor blade in order to prevent sliding of gum and suture material



You can find the TC Version of this Scissor in Chapter 04!



1/1



1/1



1/1

11.5cm, straight

03-320-115

Standard

03-320-115 SC

Super-Cut

03-316-115

Standard, large ring

11.5cm, curved

03-321-115

Standard

03-321-115 SC

Super-Cut

03-317-115

Standard, large ring

13cm, X-tra large ring

03-327-130

curved

03-327-130 SC

curved, Super-Cut

03-326-130

straight

JOSEPH



14cm,
03-440-140
 Standard
03-440-140 SC
 Super-Cut



14cm, curved
03-441-140
 Standard
03-441-140 SC
 Super-Cut

KELLY



curved, Standard
03-631-160
 16cm
03-631-180
 18cm



1/1
 straight, Standard
03-630-160
 16cm
03-630-180
 18cm



curved, Super-Cut
03-631-160 SC
 16cm
03-631-180 SC
 18cm

03

Suture & Gum Scissors

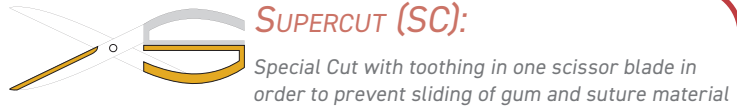
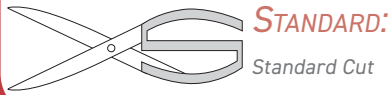

FOX



03-420-130
13cm, straight



03-421-130
13cm, curved
plain



03-417-130 SC
13cm, curved, Super-Cut

LA GRANGE



03-401-105
10.5cm
Standard
03-401-105 SC
Super-Cut

LOCKLIN

Gum Scissors

03-635-160

16cm, serrated



SPENCER



1/1

Ligature Scissors

03-720-130

13cm



1/1

03-325-115

11.5cm, angled



1/1

03-351-115

11.5cm, very fine tips

03

Special Scissors

SURGICAL SCISSORS



03-027-145
14.5cm, curved

sharp/blunt tips

03-022-145
straight, 14.5cm

03-022-175
straight, 17.5cm

BEEBEE



03-744-105
Wire-Cutting Scissors,
10.5cm, straight, sharp



03-745-105
Wire-Cutting Scissors,
10.5cm, curved, sharp

LISTER



03-781-145
Bandage Scissors, 14.5cm

UNIVERSAL



03-805-180
Universal Bandage Scissors,
18cm

04

TC SCISSORS



04

TC Suture & Gum Scissors



TUNGSTEN CARBIDE (TC):
Special Hard-Metal Inlays increasing life time and sharpness, of the Instrument

FOX

JOSEPH



04-417-130

13cm, curved,

04-441-140

14cm, curved

04-521-115

11.5cm, curved

05

MICRO SCISSORS



05

Micro Scissors

I'MOTION



05-803-180

18cm, curved



curved, round

05-809-145

14.5cm

05-809-180

18cm



05-621-145

14.5cm, very fine tips,
flat handle



05-801-145

14.5cm, x-fine tips, round

08

DISSECTING AND TISSUE FORCEPS

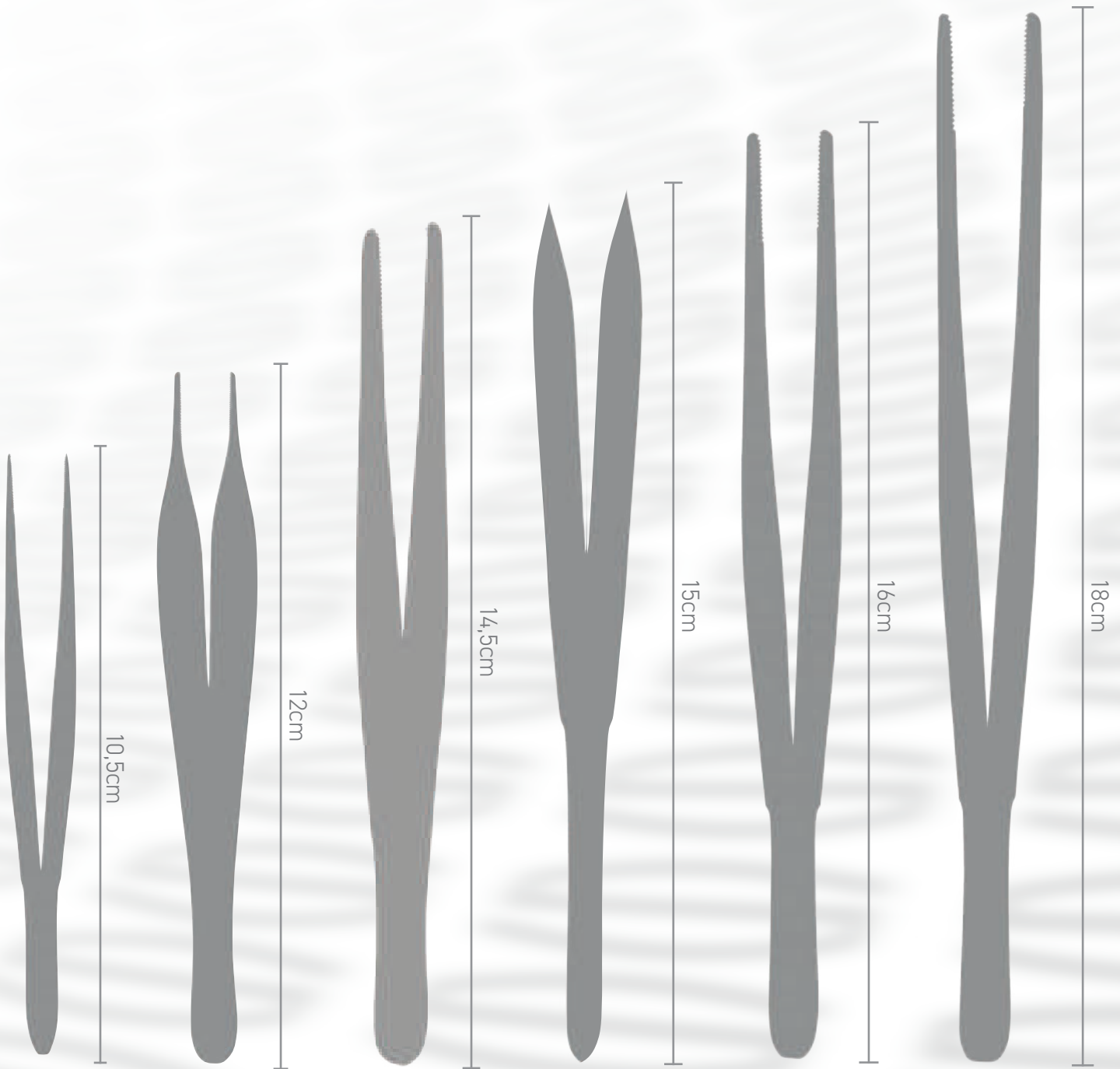

08

Dissecting Forceps



1/1



1/1



1/1



1/1

Dissecting forceps,
straight, standard

08-020-145

14,5cm

08-020-160

16cm

Dissecting forceps,
straight, delicate

08-030-145

14,5cm

08-030-160

16cm

08-030-180

18cm

Dissecting forceps,
curved, delicate

08-033-145

14,5cm

08-033-160

16cm

08-033-180

18cm

Dissecting forceps,
cross-serrated

08-036-145

14,5cm

08-036-160

16cm

08-036-180

18cm

ADSON

SEMKEN

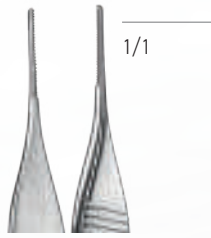

1/1

08-060-122



1/1



1/1



1/1



1/1

Dissecting forceps

08-060-120

12cm

08-060-150

15cm

08-062-150

MICRO-ADSON,
diss. forceps, 15 cm,
x-fine

08-080-155

Dissecting forceps,
15, 5 cm, straight

10-130-180

Dissecting forceps,
18 cm, delicate, TC

GERALD

SEMKEN



1/1

Tissue forceps, straight,
1x2 t., v.delic.

08-235-145
14,5cm

08-235-160
16cm

08-235-180
18cm



1/1

08-281-155

Tissue fcps., 15, 5cm,
straight, 1x2 t.



1/1

08-301-175

Tissue forceps, 17,
5cm, str., 1x2 t.

ADSON

MICRO-ADSON

ADSON-BROWN



1/1



1/1

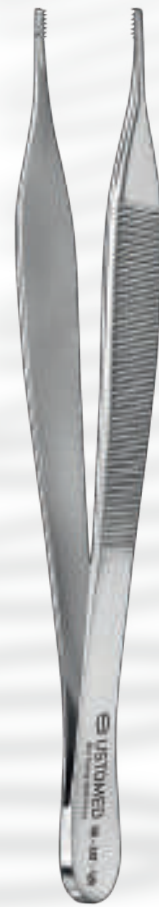

Tissue forceps, 1x2 teeth

08-261-120

12cm

08-261-150

15cm

Tissue forceps, 1x2 teeth, xfine

08-262-120

12cm

08-262-150

15cm

08-267-120

Tiss.forceps, 12cm, 7x7 teeth

09

MICRO AND ATTRAUMATIC FORCEPS

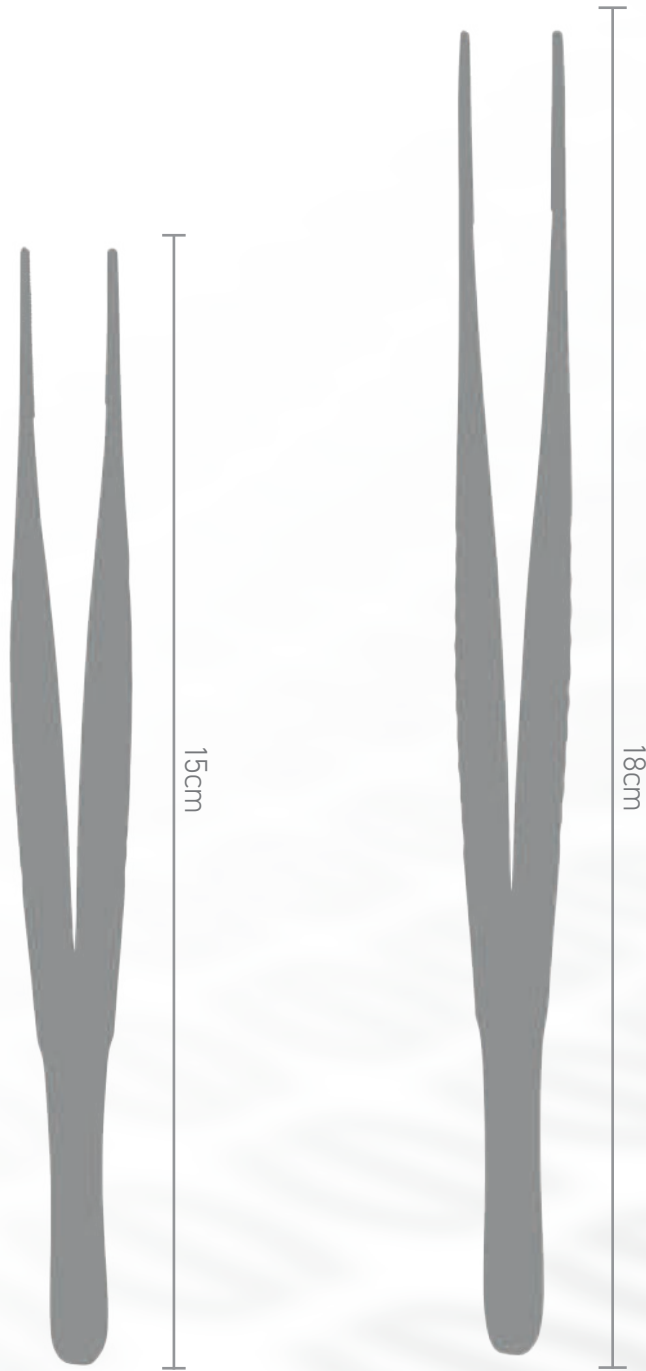

DE BAKEY - FOR TISSUES AND SUTURES

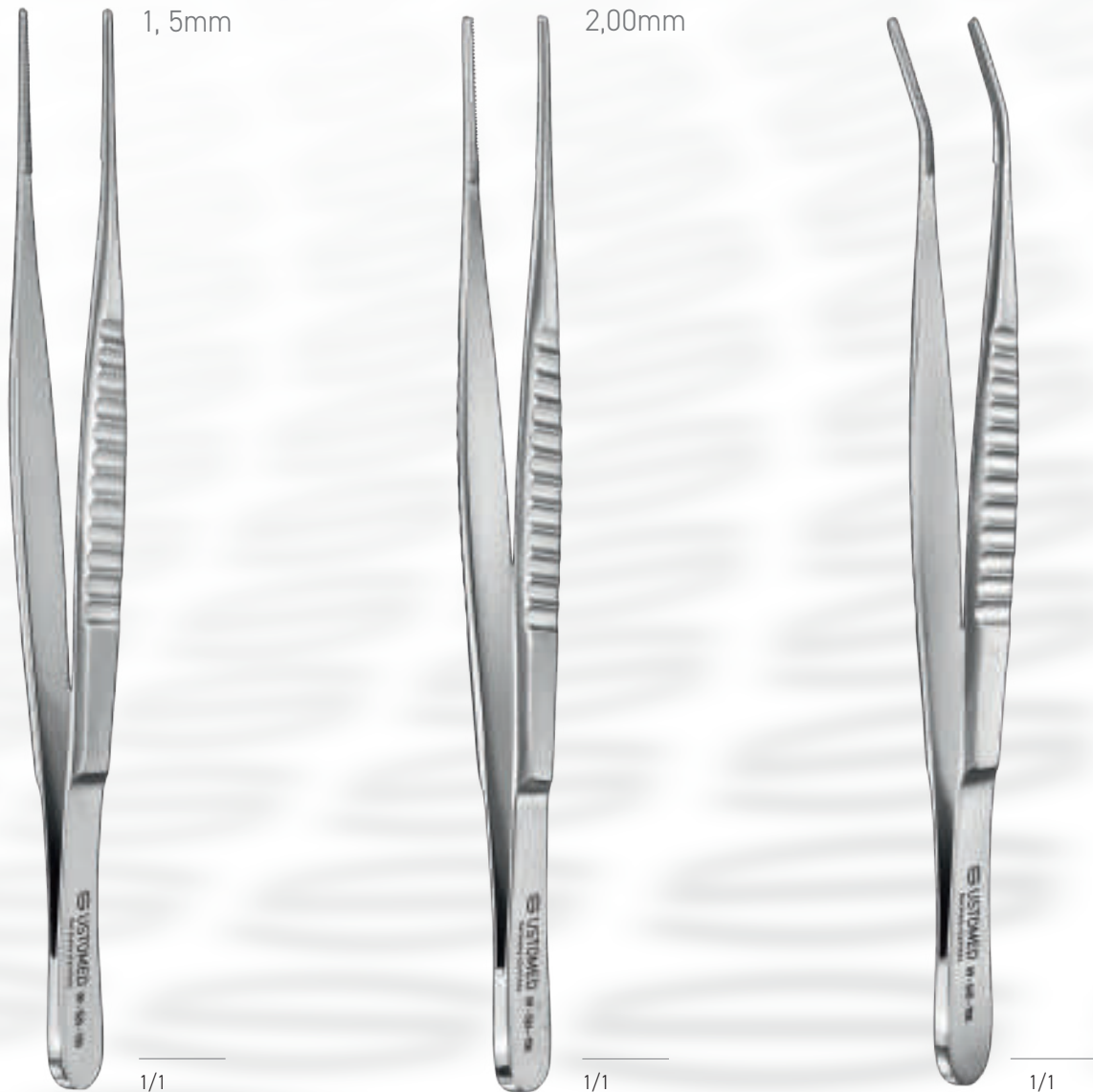

atraum. fcps., jaws 1, 5mm

09-520-150

15cm

09-520-180

18cm

atraum. fcps. jaws 2, 0mm

09-526-150

15cm

09-526-180

18cm

09-545-150

atraum. fcps., 15 cm,
angled, 2mm

09

Micro Forceps



1/1

09-230-180

Micro-dissecting forceps,
18 cm, diamond



1/1

09-267-180

Micro-tissue forceps, 18 cm,
cvd., 1, 2 mm



1/1

09-265-180

Micro-tissue forceps, 18 cm,
str., 1, 2 mm

DE BAKEY



1/1

09-270-180

DE BAKEY, micro atraum.
fcps., 18cm, str.

I'MOTION



1/1

09-280-180

I'Motion, Micro-forceps,
Cooley,

10

COLLEGE FORCEPS AND MEASURING INSTRUMENTS

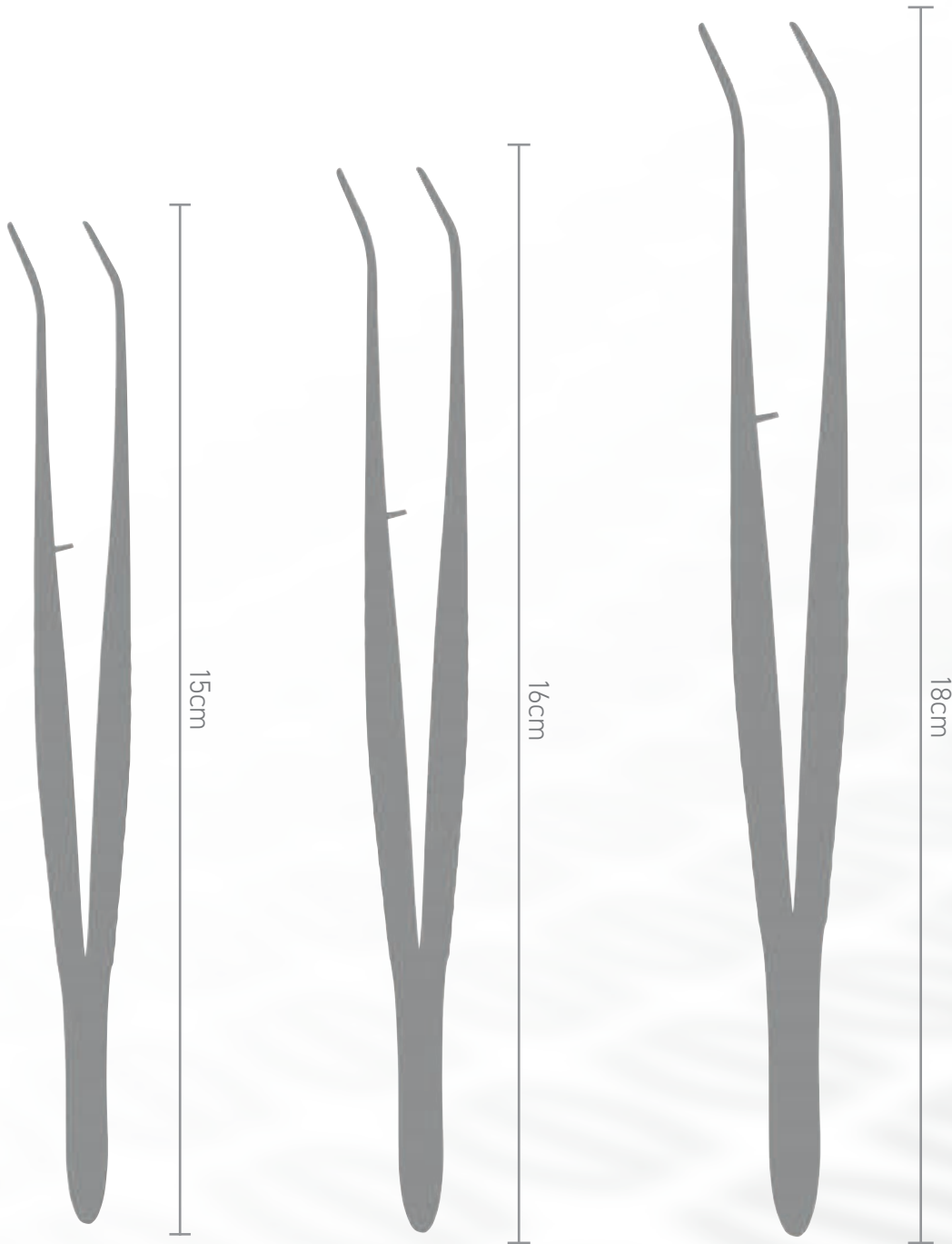

LONDON COLLEGE

LONDON COLLEGE modified



10-801-150

Tweezers, 15 cm,
serrated jaws

Modif., tweezers,
strong patt

10-825-150

15cm

10-825-160

16cm

10-825-180

18cm

10-827-150

Modif., tweezers,
strong patt.diam

10-829-150

Modif., tweezers,
counter-ang.

MERIAM



1/1

10-831-160

Tweezers, 16 cm,
serrated jaws



1/1

10-841-160

Tweezers, 16 cm, serrated
jaws

10-845-155

Modif., tweezers, smooth
handles



1/1

10-130-180

Dissecting forceps,
18 cm, delicate, TC



1/1

Splinter forceps, 10, 5 cm,
serr.

08-452-105

straight

08-453-105

curved



1/1

10-823-160

Maxgraft-Bone-Ring
forceps, 16 cm



1/1

10-871-160

Suture forceps, 16 cm, with
eye tips

10

Special Forceps and Tweezers

PONTE



1/1

10-877-160

PONTE, Bone-Block holding forceps, 16cm,



1/1

10-883-150

Nerve broach pliers, with lock

MILLER



1/1

10-947-150

MILLER, forceps for articulating paper



10-941-000

IWANSON, caliper, meas. range 0-10 mm



1/1

10-942-150

Ruler, 15 cm, metal



10-943-000

ZIELINSKY, measuring caliper

HEMOSTATIC FORCEPS



HALSTED-MOSQUITO



curved

13-039-

14 cm

13-039-125

12,5 cm



straight

13-038-125

12,5 cm

13-038-140

14 cm

13

Hemostatic Forceps

ROCHESTER-PEAN

MICRO-MOSQUITO



13-029-120
12 cm, curved



13-201-140
14 cm, curved

HALSTED-MOSQUITO

13-031-120

12 cm, curved, 1x2 teeth



OCHSNER-KOCHER



MICRO-MOSQUITO

HALSTED-

13-043-125

12,5 cm, curved

13-043-140

14 cm, curved

13-042-125

12,5 cm, straight



13-215-140

14 cm, curved, 1x2 teeth

AUXILLARY CLAMPS AND FORCEPS



GROSS MODIFIED



1/1

17-013-180

Sponge holding Forceps,
curved, with interlock

BACKHAUS



1/1

Towel Clamp

17-251-110

11cm

17-251-080

8cm

17

Auxillary Clamps and Forceps



1/1

17-271-120

Towel Clamp, 12 cm,
paper/towels

JONES



1/1

17-227-090

Towel Clamp, 9 cm,
curved

STIEGLITZ



1/1

17-717-135

Splinter forceps, angled,
diamond-coated



1/1

Forceps, for seizing and
steril. of instruments

17-793-200

20 cm

17-790-145

14,5 cm

NEEDLE HOLDER





19-170-160

16 cm



19-300-140

14 cm

19-300-170

17 cm

TC NEEDLE HOLDER

TC = TUNGSTEN CARBIDE

An extremely durable metal, that is harder than most common suture-needles! This inlay increases the longevity of our needle holders dramatically. The inlays are able to change.

The gold-plated handle indicates TC inserts.



HALSEY

BABY-CRILE-WOOD



1/1

20-120-130

13 cm

3/0 - 5/0



1/1

20-160-150

15 cm

4/0 - 5/0

CRILE-WOOD



20-164-150
15 cm) 3/0 - 5/0



20-164-180
18 cm) 3/0 - 5/0

MAYO-HEGAR

MICRO-RYDER



1/1

20-220-160

16 cm

) 2/0 - 4/0

20-220-180

18 cm

) 2/0 - 4/0



1/1

20-320-150

15 cm

) 5/0 - 7/0

20-320-130

13 cm

) 6/0 - 7/0

MATHIEU MODIFIED



INFO
 modified lock mechanism prevents the glove to get caught in the lock.

- 20-452-170
17 cm } 3/0 - 4/0

- 20-452-140
14 cm } 3/0 - 4/0

- 20-452-200
18 cm } 3/0 - 4/0

LICHTENBERG



20-471-170
17 cm, curved

- 20-470-170
17 cm, straight } 3/0 - 4/0

HÖSEL



1/1

20-480-200

20 cm, straight, extra-long

3/0 - 4/0

20

TC Needle Holder

LANGENBECK



20-392-160

16 cm

) 3/0 - 5/0

20-392-180

18 cm

) 3/0 - 5/0

TOENNIS



20-398-180

18 cm

) 3/0 - 4/0

CASTROVIEJO



20-681-140

14 cm, curved,
flat handle

1/1



1/1

20-680-140

14 cm, straight,) 5/0 - 7/0
flat handle



20-681-180

18 cm, curved,
flat handle

1/1



1/1

20-680-180

18 cm, straight,) 5/0 - 7/0
flat handle

20

TC Micro-Needle Holder

BARRAQUER



20-710-140

14 cm, straight,
round handle

5/0 - 7/0

20-710-180

18 cm, straight,
round handle

5/0 - 7/0

20-711-140

14 cm, curved,
round handle

5/0 - 7/0

20-711-180

18 cm, curved,
round handle

5/0 - 7/0

I'MOTION



1/1



1/1

20-752-180

18 cm, straight

INFO

- extremely light
- plasma-coated tips
- easy to clean

20-753-180

18 cm, curved

5/0 - 7/0

RETRACTORS



GILLIES

KILNER



24-421-150

15 cm, 1 fork, sharp



Fig. 1

24-425-001

18 cm, size 1, small



Fig. 2

24-425-002

18 cm, size 2, large

24

Tissue Retractors

JOSEPH

GUTHRIE



24-469-002

15 cm, 2 forks, sharp



24-573-002

16 cm, 2 forks, 2 mm



24-573-007

16 cm, 2 forks, 7 mm



24-021-001
single fork, 16 cm, sharp



24-021-002
double fork, 16 cm, sharp



24-023-001
single fork, 16 cm, blunt

24

Cheek Retractors

MINI- LANGENBECK

CAWOOD- MINNESOTA

GIERL



24-153-000
Cheek Retractor

24-154-160
16 cm

24-157-155
15,5 cm



84-239-000

GLUCKMANN, PET-Shield holder, double-sided

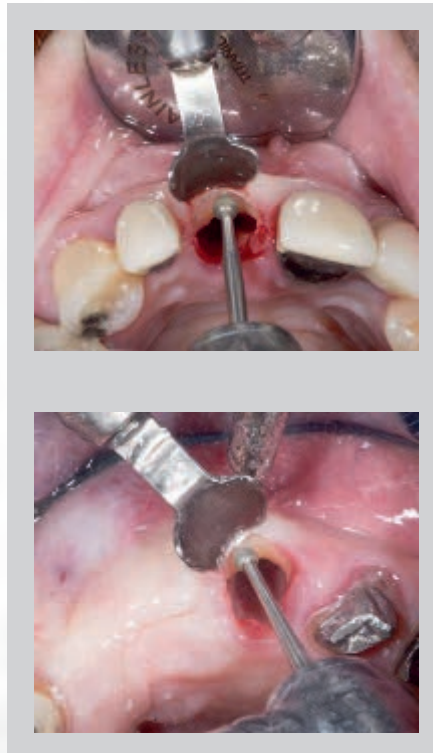

INFO

Special tool for the Advanced Socket Shield Technique: „PET“ by Dr. Howard Gluckman.

Helps you to secure the gingiva, when preparing the buccal root during the procedure.



24-158-002

PET Shield, right



24-158-001

PET Shield, left

24

Cheek Retractors

MIDDELDORPF

HILGER



1/1



1/1

24-159-001

Cheek Retractor,
only, compatible
to mouth mirror
handles

24-159-000

Cheek Retractor,
complete with handle



1/1

24-161-002

22 cm, size 2, medium

LANGENBECK



Wound Retractor
21 cm

KOCHER

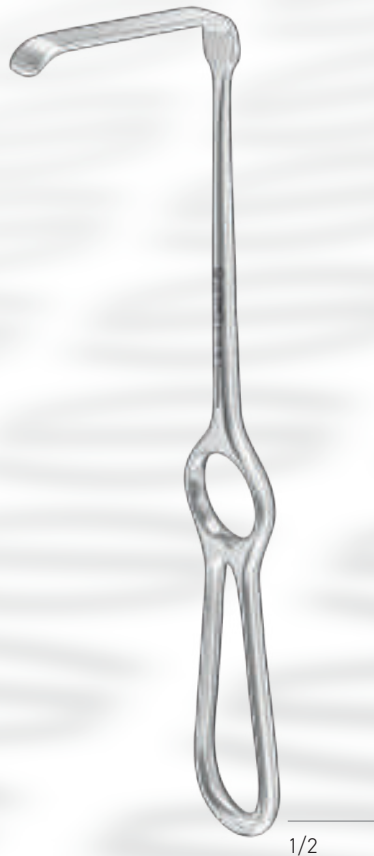
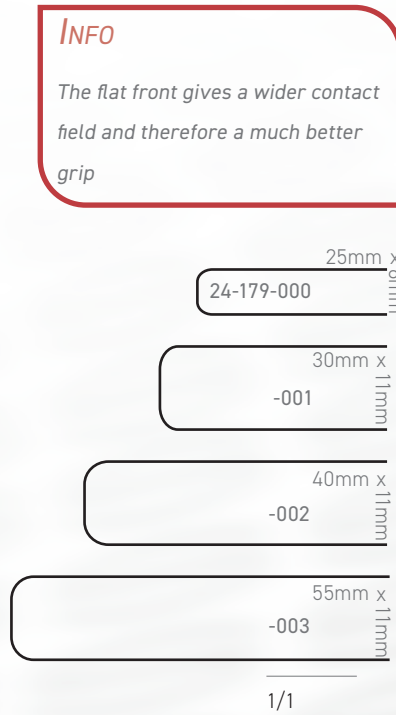

Wound Retractor
22 cm

OBWEGSER

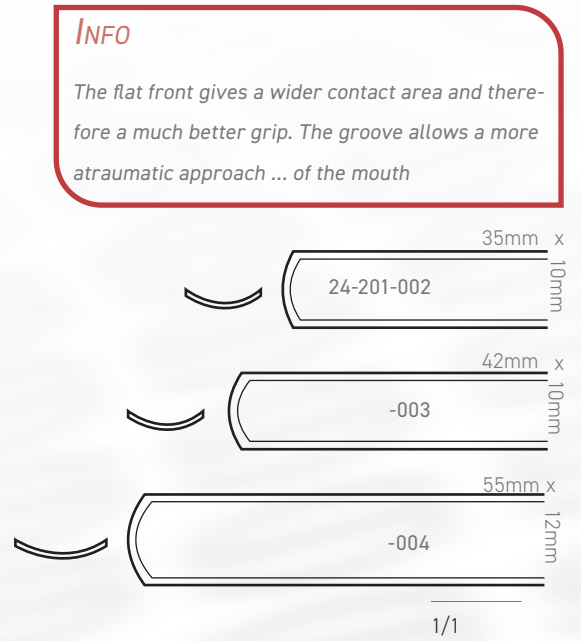

Wound Retractor
24 cm

INFO

The flat front gives a wider contact field and therefore a much better grip

INFO

The flat front gives a wider contact area and therefore a much better grip. The groove allows a more atraumatic approach ... of the mouth

24

Wound & Special Retractors

KOCHER- TROSSBACH



24-179-

size 3, 55 x 11mm,
bended upwards

NENTWIG



24-191-230

Zygomatic Retractor,
23 cm

24-191-014

Special Retractor,
70x14mm, serrated

USTOMED

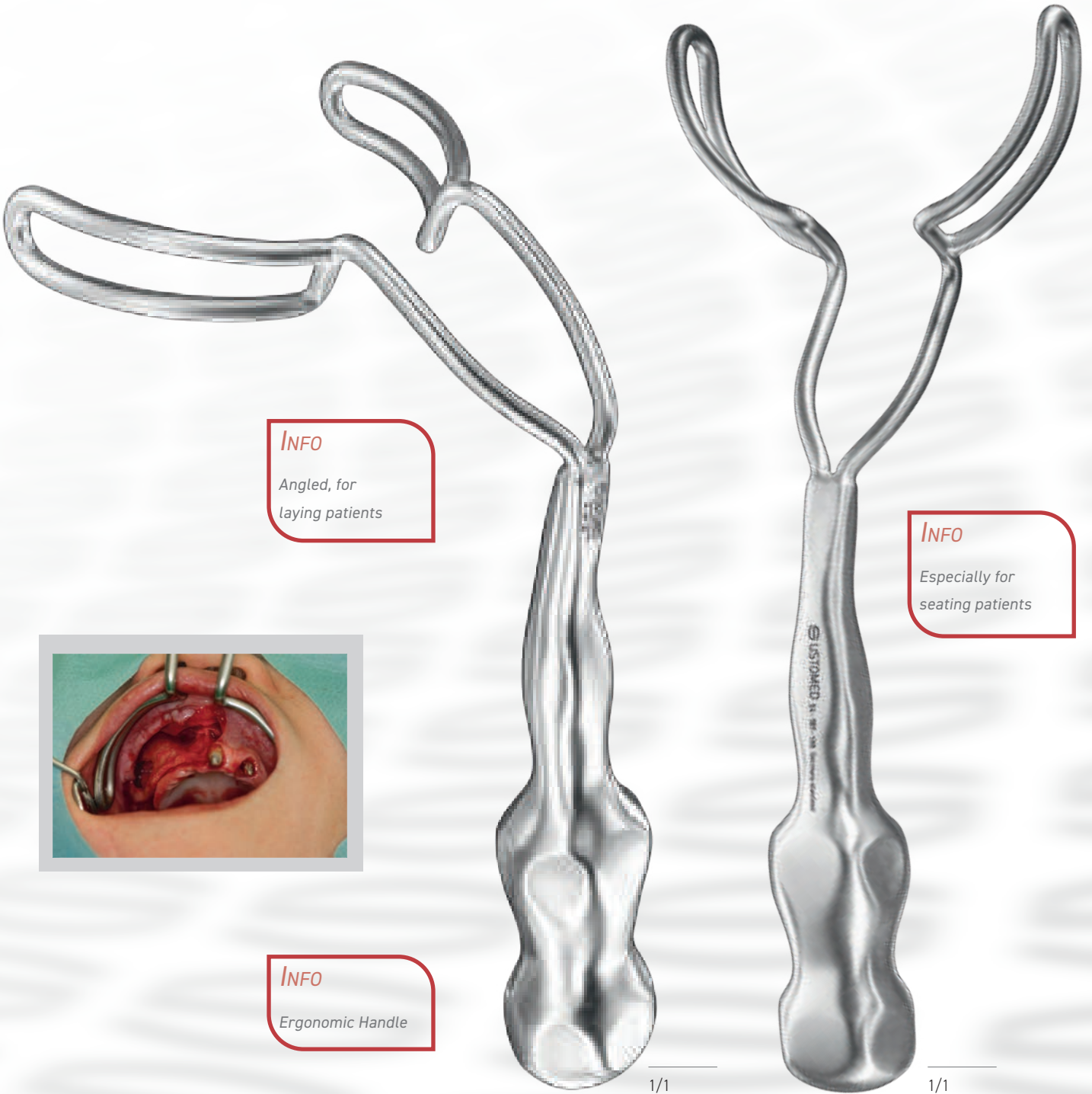

INFO
 Angled, for
 laying patients

INFO
 Especially for
 seating patients

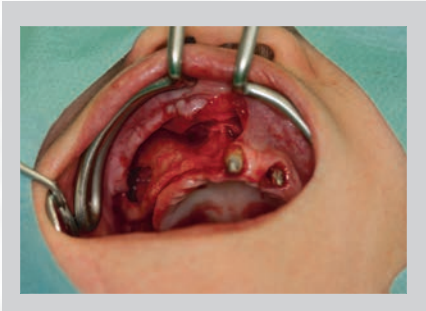

INFO
 Ergonomic Handle

1/1

1/1

24-189-180
 universal, angled

24-187-
 universal, straight

LASTER

BRAANEMARK



1/1

24-186-150

80mm



1/1

24-203-105

Retractor, for upper impacted wisdom

HILGER

24-197-001

cheek and lip spreader,
size 1



24-197-002

cheek and lip spreader,
size 2

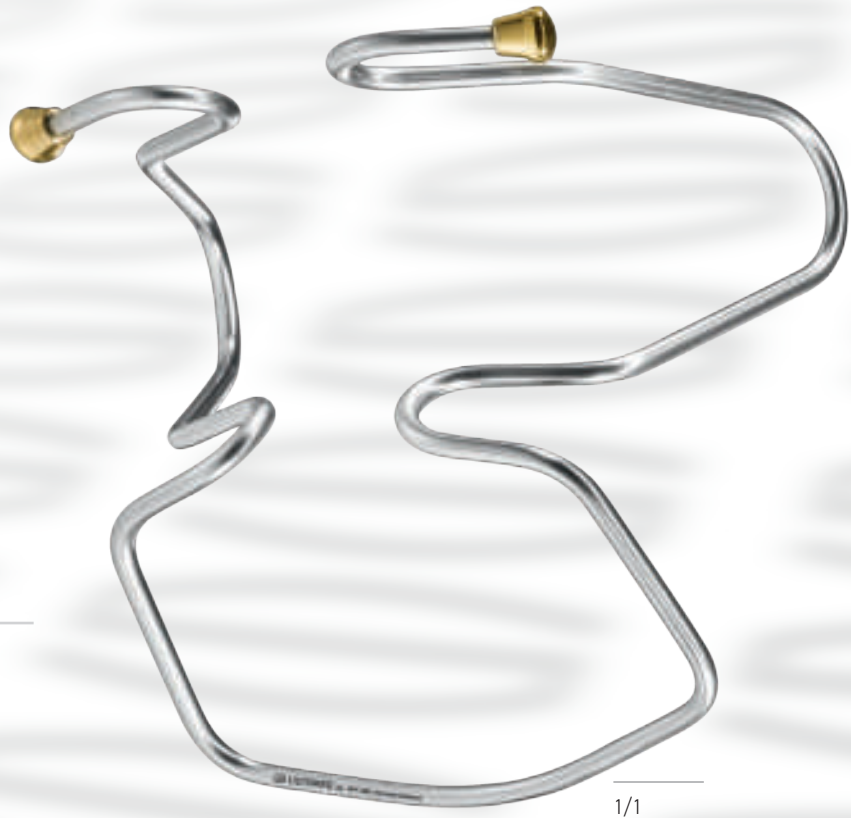

24

Cheek and Lip Spreaders

SPANDEX

INFO

Cheek and lip spreaders self-expanding, plastic material, autoclavable up to 180° C.



1/1

24-395-001

size 1, pack of 2



1/1

24-395-002

size 2, pack of 2

ELEVATORS AND RASPATORIES



WILLIGER



27-741-160

Raspatory,
16 cm,
curved

27-745-160

Raspatory,
16 cm,
curved, wide

27-743-130

Raspatory,
13 cm,
curved

27-749-006

Raspatory,
17,5 cm, 6mm

PRICHARD

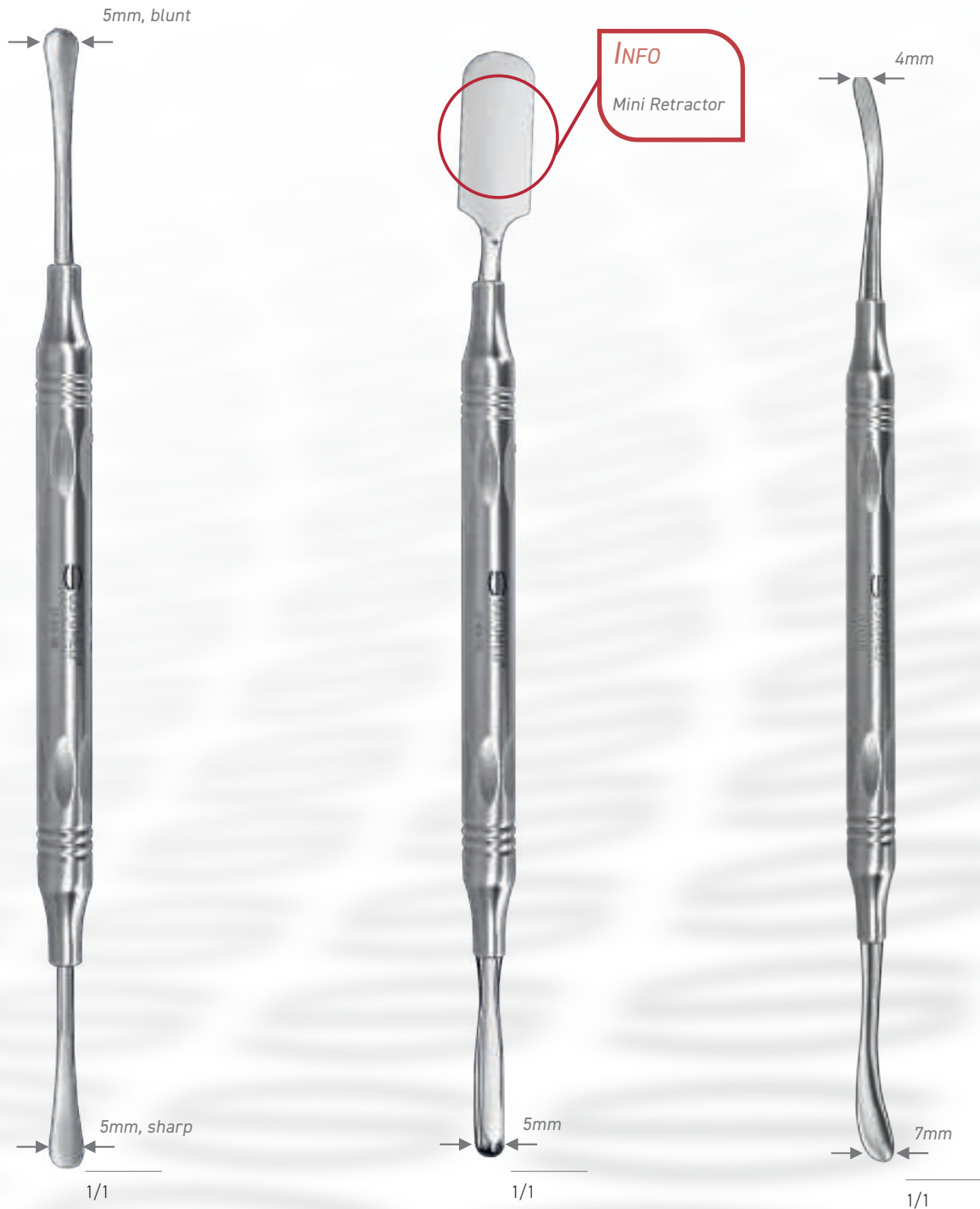

27-451-180

Elevator, 18 cm,
double-ended,
sharp/blunt

27-451-180P0T3

Elevator, 18 cm,
double-ended, sharp/
blunt, peek handle

27-459-175

Raspatory PR3, 17,5 cm,
double-ended

27-459-175P0T3

Raspatory PR3, 17,5 cm,
double-ended, peek handle

27-717-175

Raspatory, 17,5 cm,
double-ended, curved

27-717-175P0T3

Raspatory, 17,5 cm,
double-ended, curved,
peek handle

27

Elevators and Raspatories

PARTSCH

MOLT

GLICKMAN

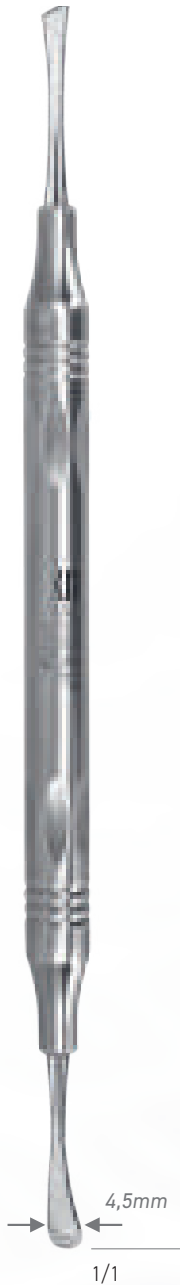

27-711-024

Raspatory No.24G, 16,5 cm



67-711-002

PARTSCH, Raspatory,
one-sided



27-721-190

Raspatory, 19 cm,
double-ended, curved

ZUCCHELLI



INFO
black coated tips, allow better visuability under gingiva

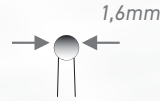

85-814-175P0T3
Mod. Z, peek handle

85-812-175P0T3
Mod. W, peek handle

85-812-175
Mod. W, peek

KASAJ

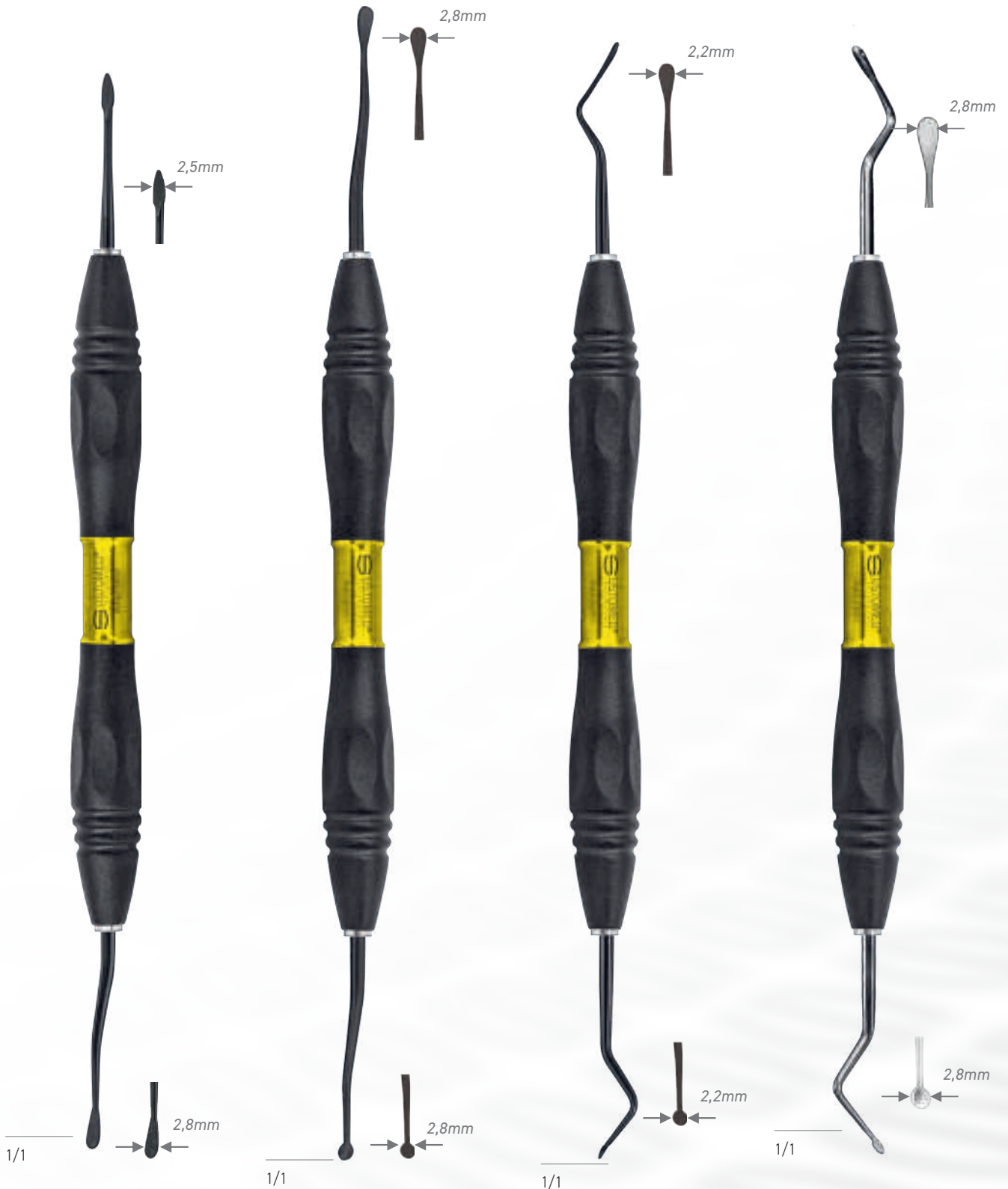

85-816-170P0T3

Mod. B,

85-818-001P0T3

Tunnelling knife,
micro, 20cm,
posterior, peek

85-818-002P0T3

Tunnelling knife,
micro, 19cm,
anterior, peek

85-818-175P0T3

Tunneling knife,
19 cm, anterior,



1/1



1/1



1/1



1/1

85-816-175

Mod. B, 17,5 cm,
peek handle

85-816-175POT3

Mod. B, 17,5 cm

85-808-175POT3

Mod. W, 18,5 cm

85-808-175

Mod. W, 17,5 cm,

BONE RONGEURS



MICRO

FRIEDMAN

LUER



1/1



1/1



1/1

31-319-145

14cm / 25° curved

31-321-140

Bone rongeur, 14 cm,
curved

31-379-150

16 cm, curved, medium

31

Bone Rongeurs

BEYER

DELICATE



31-315-150

15 cm, curved



31-421-180

Bone Rongeur, 18 cm,
curved, transmitted

MEASURING DEVICES

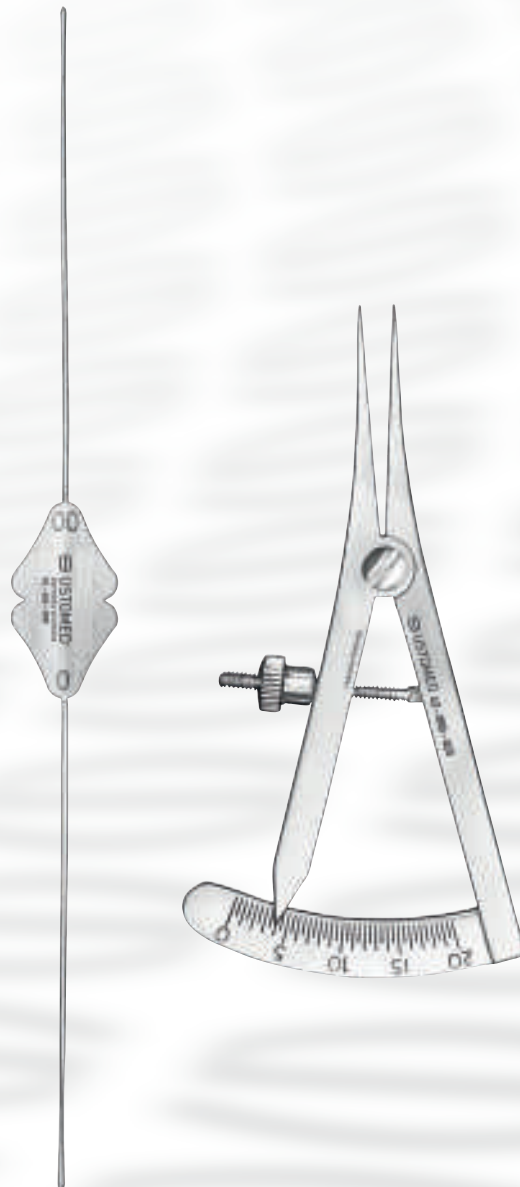

BOWMAN



1/1

Antrum probe, ball-point

42-652-000
size 00/0



42-652-012
size 1/2



42-652-034
size 3/4



42-652-056
size 5/6



42-652-078
size



42-652-300
sz.000/00



42-652-400
0000/000

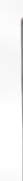

CASTROVIEJO

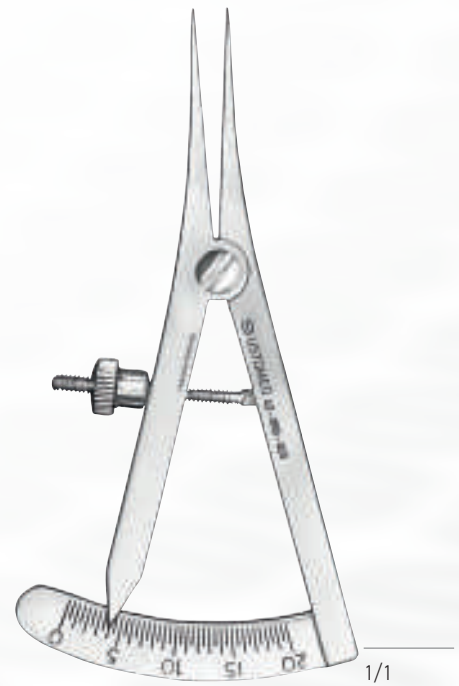

1/1

42-850-020

Implantology caliper,
20 mm, straight

SINUS CURETTES



KHOURY SEMI-SHARP

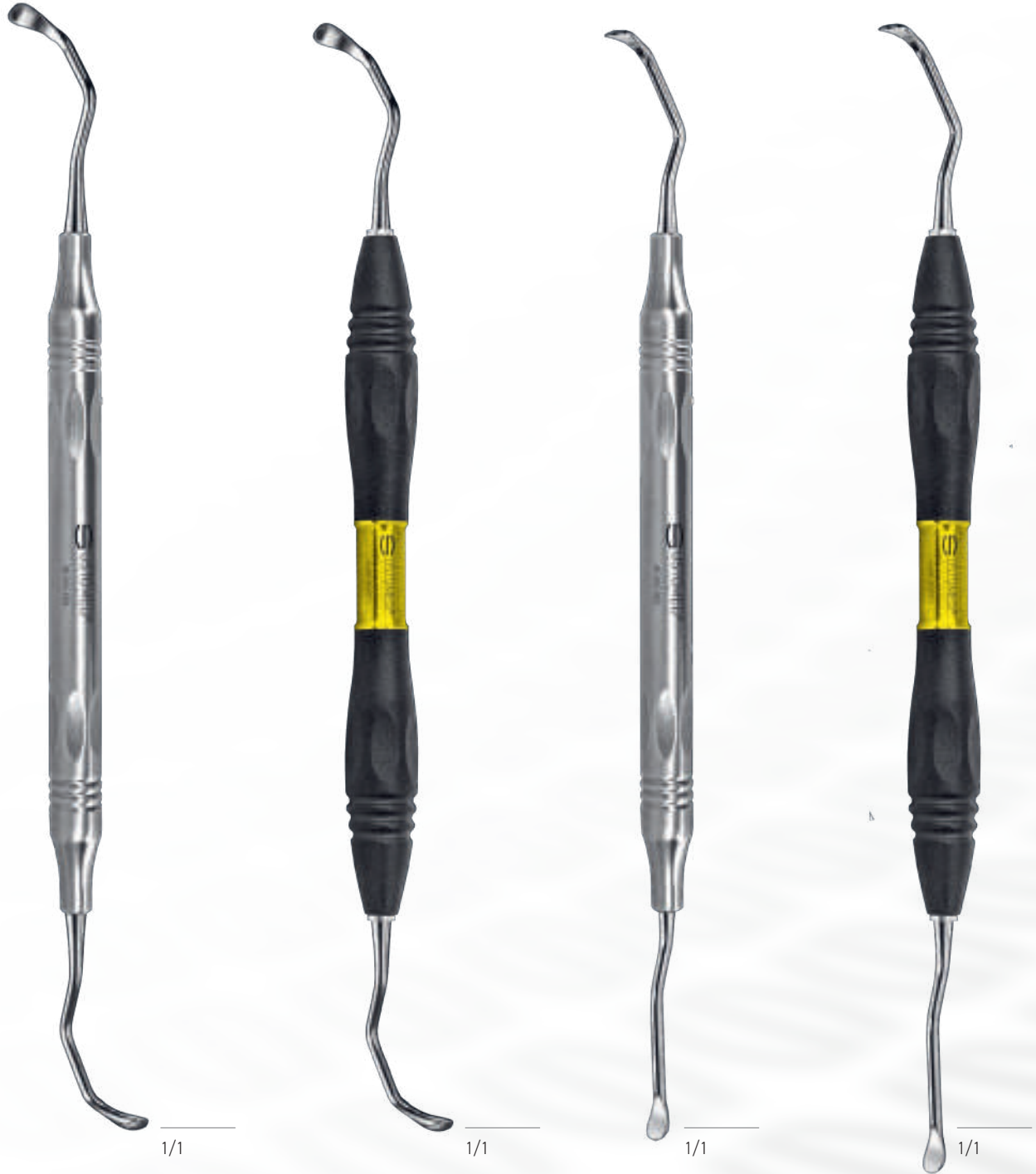

46-695-004

Sinus Curette, Fig. 4, 180 mm, semi-sharp

46-695-004POT3

Sinus Curette, Fig. 4, 180 mm, semi-sharp, peek handle

46-695-003

Sinus Curette, Fig. 3, 180 mm, semi-sharp

46-695-003POT3

Sinus Curette, Fig. 3, 180 mm, semi-sharp, peek handle

HOTZ

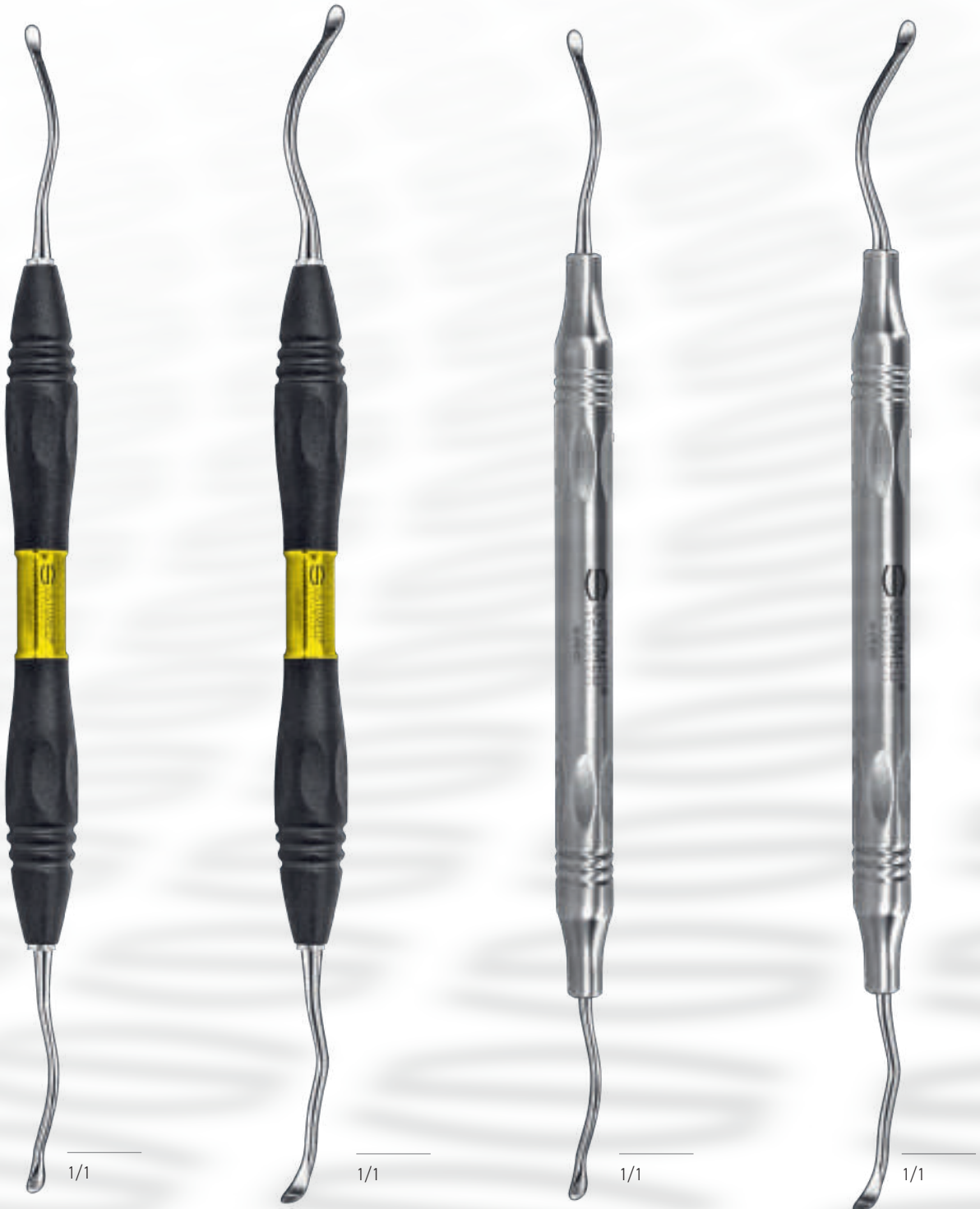

46-695-001POT3

Sinus Curette, Fig. 1,
185 mm, semi-sharp

46-695-002POT3

Sinus Curette, Fig. 2,
190 mm, semi-sharp

46-695-001

Sinus Curette, Fig. 1,
185 mm, semi-sharp

46-695-002

Sinus Curette, Fig. 2,
190 mm, semi-sharp

46

Sinus Currettes

NENTWIG SHARP



46-699-001P0T3

Sinus Curette, Fig. 1,
180 mm, sharp, peek
handle

46-699-002P0T3

Sinus Curette, Fig. 2,
190 mm, sharp, peek
handle

46-699-003P0T3

Sinus Curette, Fig. 3,
190 mm, sharp, peek
handle

46-699-004P0T3

Sinus Curette, Fig. 4,
190 mm, sharp, peek
handle

MOUTH WEDGES, GAGS & PACKING INSTRUMENTS



48

Mouth Wedge



48-091-001

Mouth Wedge



48-091-002

Mouth Wedge



48-081-001

Mouth Wedge, plastic, size M



48-081-002

Mouth Wedge, plastic, size L

48-149-200

Silicone tube, 2 m,
sterilizable, compatible
with 48-141-140, 48-145-
120, 48-149-000

MOLT



1/1

48-141-140

Mouth gag, 14 cm, for
adults

DENHART



1/1

48-145-120

Mouth gag, 12 cm, fine ratchet

48

Mouth Gag

48-149-200

Silicone tube, 2 m, sterilizable, compatible with 48-141-140, 48-145-120, 48-149-000

USTOMED



48-149-000

Set, complete, DBGM



48-149-001

Scoop for 48-149-000, single part, for children



48-149-002

Scoop for 48-149-000, single part, for adults

HABERER

BRUENINGS

TOBOLD



1/1

48-260-200

Tongue depressor, 20 cm,
17x25 mm, bendable



1/1

48-255-190

Tongue depressor, 19
cm



1/1

48-271-165

Tongue depressor, 16,5 cm

48

Packing Instruments

LUNIATSCHEK



1/1

48-339-002

INFO
Points slightly rounded, hence less traumatizing and less painful for the patient.

1/1

48-339-001

Gauze Packer, narrow, 17,5 cm



1/1

48-351-165

INFO
Very thin and flexible working ends slightly twisted in themselves, thus making possible to operate more simply and more carefully than with the conventional method using the Heidemann spatula.

1/1

48-349-165

Retraction thread packer, smooth



1/1

48-353-165

Retraction thread packer, plate form

67/68 BONE PREP INSTRUMENTS AND TOOLS



67

Plugger

DEGIDI



1/1

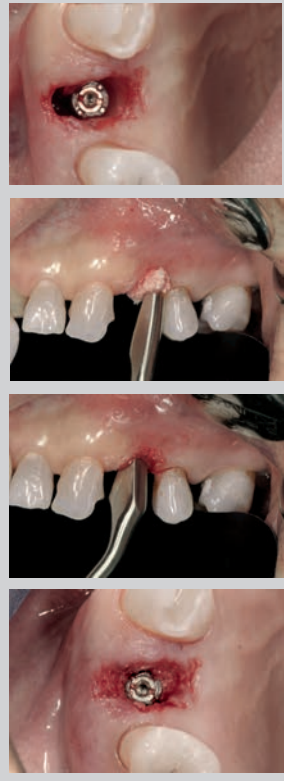

1/1

INFO

Special instruments for filling and condensing bone material around an implant.

67-693-012P0T3

DEGIDI Plugger,
size 1/2, peek
handle

67-693-034P0T3

DEGIDI Plugger,
size 3/4, peek
handle

RHODES



1/1

67-545-367P0T3

Back-Action Chisel,
size 36/37, peek
handle



1/1

85-802-305P0T3

Bone Scraper, Mod.
B, 3 and 5 mm
width, peek handle



1/1

67-691-003P0T3

Filler and Plugger for
biomaterials, peek
handle



1/1

67-691-008P0T3

Filler and Plugger for
biomaterials, peek
handle

MINI-LAMBOTTE



67-555-004 S

13 cm, 4 mm,
curved, scaled

67-554-004S

13 cm, 4 mm,
scaled, straight

67-555-006 S

13 cm, 6 mm,
curved, scaled

67-554-006S

13 cm, 6 mm,
scaled, straight

67-555-008 S

13 cm, 8 mm,
curved, scaled

67-554-008S

13 cm, 8 mm,
scaled, straight

67-555-010 S

13 cm, 10 mm,
curved, scaled

67-554-010S

13 cm, 10 mm,
scaled, straight



1/1

67-711-002
size 2, 15 cm



67-678-170

Bone Grinding Pliers

NENTWIG

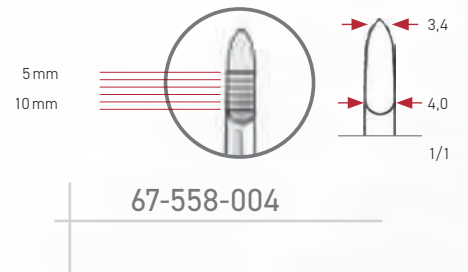
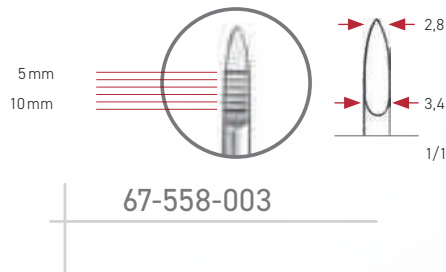
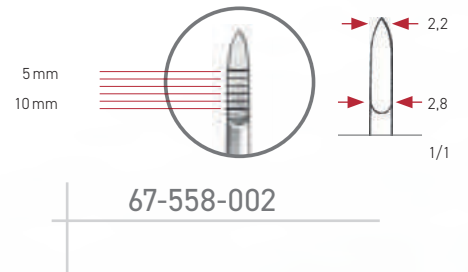
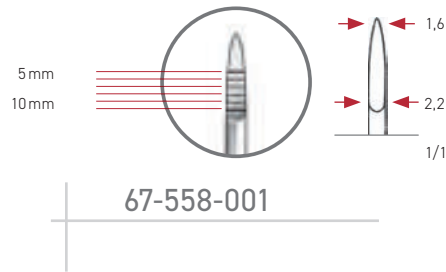

Localized spreading of the narrow ridge



67-558-444

Set, size 1-4, straight, scaled

NENTWIG

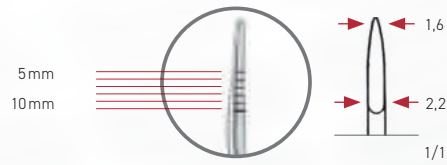
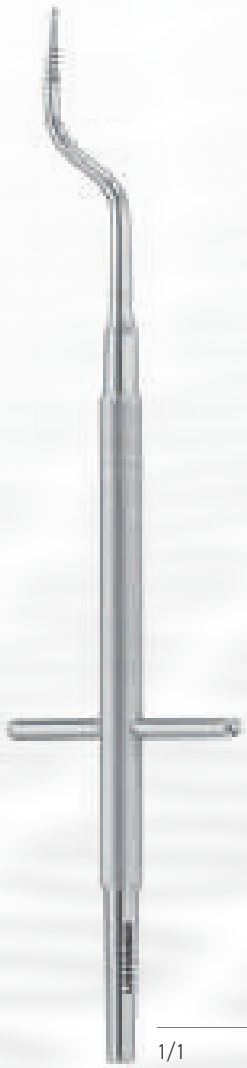

67-559-001

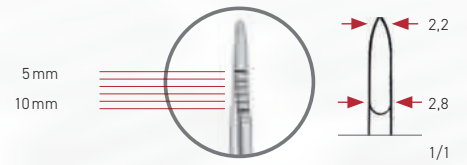

67-559-002

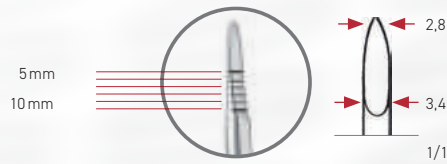

67-559-003

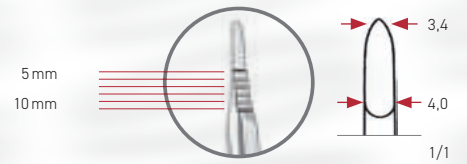

67-559-004

Condensing: preparation of the implant site when bone structure is compromised



67-559-444

Set, size 1-4, bajonet, scaled

USTOMED BONE MILL



Mill, complete Set, with Cutting Cylinder and Collector

67-682-002

size S

67-682-003

size M

67-682-004

size L



67-682-012

Cutting Cylinder, size S,
ca. 2 mm bone flakes



67-682-013

Cutting Cylinder, size M,
ca. 3 mm bone flakes



67-682-014

Cutting Cylinder, size L,
ca. 4 mm bone flakes



67-682-020

Collector

67

Mallets

INFO

exchangeable
teflon inlays

67-636-002

Teflon Discs, for
67-636-210, 2 pcs.

INFO

Completely
made from steel

INFO

Most common
mallet for use
with pins



1/1

67-660-150

16,5 cm, 150 g



1/1

67-636-210

18,5 cm, 210 g, Ø 25 mm

OMBREDANNE



1/1

67-670-720
26 cm, 720 g



Photo Copyright Dr. Ponte



1/1

67-680-000
Bone crusher, round

LUCAS



67-797-085

size 85, 17 cm, double-ended

67-797-085P0

peek handle

67-797-086

size 86, 17 cm, double-ended

67-797-086P0

peek handle

67-797-087

size 87, 17 cm, double-ended

67-797-087P0

peek handle

67-797-186P0T3

size 86, 17 cm, double-ended, serrated

HEMINGWAY



18cm, double-ended

67-799-000
size 0



67-799-010
size 1



67-799-020
size 2



67-799-030
size 3



67-799-040
size 4



67-799-010P0
size 1



67-799-020P0
size 2



67-799-030P0
size 3

67-799-040P0
size 4



18cm, double-ended

67-799-000P0
size 0, peek handle

1/1

1/1

67

Bone Condenser, Osteotomes

INFO
Suitable for internal Sinus Lift.

INFO
Stopper is adjustable
seamlessly.



67-851-030
Ø 3,0 mm



67-851-033
Ø 3,3 mm



67-851-040
Ø 4,0 mm

67-851-020

Bone Condenser, bajonet, concave, Ø 2,0 mm

USTOMED TITAN-PIN-SET

68-780-018

Titan-Pin-Set,



SET INCLUDES:



TITAN-PINS

68-620-003

Titan-Pins, 3mm, 10 pcs.

INFO

Suitable mallett 67-660-150
(see page 98)



APPLICATOR

- Single-piece instruments to collect the pins from the holding tray therefore the twisting of the working tip during the operation is excluded.
- Very ergonomical and comfortable Grip for a safe operation of the Titan-Pins

68-650-000

Applicator, for pins 68-620-003, 15,5cm



HOLDING TRAY

- Functional Design
- safe and easy to operate with single hand principle
- Box can contain up to 15 Titan-Pins

68-720-008

Box for 15 Titan-Pins

68

Augmentation

68-780-016

Bone-Fixation-Set, Titan,
1,2mm / 1,4mm Ø



CONTENTS:

- 68-720-002 Box for Micro-Screws Ø 1,0/ 1,2/ 1,4mm
- 68-740-002 Screwdriver, 11cm, Fig. 2
- 68-760-102 Blade, cross, self-retaining, 60mm length, for 68-740-002
- 68-510-014 Pilot drill, Ø 1, 0mm, 14mm
- 68-512-014 Pilot drill, Ø 1, 2mm, 14mm
- 68-112-008 Titanium, Ø 1,2mm, 8mm length, cross, 10 pcs.
- 68-115-004 Membrane Screws, selfcutting, 4mm, 10 pcs.

MATCHING ITEMS:

Accesso-

- 68-720-002 Box for Micro-Screws Ø 1,0/ 1,2/ 1,4mm
- 68-740-002 Screwdriver, 11cm, Fig. 2
- 68-760-106 Blade, cross, self-retaining, short, for Contra-Angle

Pilot Burs:

- 68-510-014 Pilot drill, Ø 1, 0mm, 14mm
- 68-512-014 Pilot drill, Ø 1, 2mm, 14mm
- 68-514-014 Glide Hole drill, Ø 1, 4mm, 14mm

Micro Screws (10 pcs. per Pack):

- 68-112-006 Titanium, Ø 1,2mm, 6mm length, cross, 10 pcs.
- 68-112-008 Titanium, Ø 1,2mm, 8mm length, cross, 10 pcs.
- 68-112-011 Titanium, Ø 1,2mm, 11mm length, cross, 10 pcs.
- 68-112-013 Titanium, Ø 1,2mm, 13mm length, cross, 10 pcs.
- 68-114-006 Titanium, Ø 1,4mm, 6mm length, cross, 10 pcs.
- 68-114-008 Titanium, Ø 1,4mm, 8mm length, cross, 10 pcs.
- 68-114-011 Titanium, Ø 1,4mm, 11mm length, cross, 10 pcs.
- 68-114-013 Titanium, Ø 1,4mm, 13mm length, cross, 10 pcs.
- 68-115-004 Membrane Screws, selfcutting, 4mm, 10 pcs.

68-780-010

Bone-Fixation-Set, Steel,
1,0mm \emptyset

**CONTENTS:**

- 68-720-002 Box for Micro-Screws \emptyset 1,0/ 1,2/ 1,4mm
- 68-740-002 Screwdriver, 11cm, Fig. 2
- 68-508-014 Pilot drill, \emptyset 0, 8mm, 14mm
- 68-110-011 S Steel, \emptyset 1,0mm, 11mm lenght, cross, 10 pcs.

MATCHING ITEMS:**Accesso-**

- 68-720-002 Box for Micro-Screws \emptyset 1,0/ 1,2/
- 68-740-002 Screwdriver, 11cm, Fig. 2
- 68-760-106 Blade, cross, sefl-retaining, short, for Contra-Angle

Pilot Burs:

- 68-508-014 Pilot drill, \emptyset 0, 8mm, 14mm
- 68-510-014 Pilot drill, \emptyset 1, 0mm, 14mm

Micro Screws (10 pcs. per Pack):

- 68-110-008 S Steel, \emptyset 1,0mm, 8mm lenght, cross, 10 pcs.
- 68-110-011 S Steel, \emptyset 1,0mm, 11mm lenght, cross, 10 pcs.
- 68-110-013 S Steel, \emptyset 1,0mm, 13mm lenght, cross, 10 pcs.

BOX FOR MICRO SCREWS AND ACCESSORIES

- Sophisticated and functional Design
- Integrated ruler for the exact determination of screw and graft lengths (removable)
- Newly-developed Material by Aerospace Engineering
- THERMOSTABLE
- All parts are suitable for machine processing in the thermodisinfector as well as for all conventional methods, thus corresponding to the latest „RKI - Guidelines“
- Collection tray for all Ustomed screw sizes-diameter (1,0 mm to 1,4 mm)



SCREW DRIVER

- perfect handle length – therefore suitable for all hand sizes
- The ergonomic handle allows a comfortable and fatigue-free operation
- Self-holding mechanism for collecting screws





Foto: Dr. Jan Kielhorn



INNOVATIVE GEOMETRY OF THE MICRO SCREWS

- Precisely milled cross-slit screw head
- all screw types (1,0mm bis 1,4mm) are to be collected with the same blade
- Fast and safe collection of the self-holding micro screws
- Extreme friction between screw head and blade, prevents wear-and-tear
- Much easier removal of debris from the cross-slit (in comparison to inner four-edge or Torx)

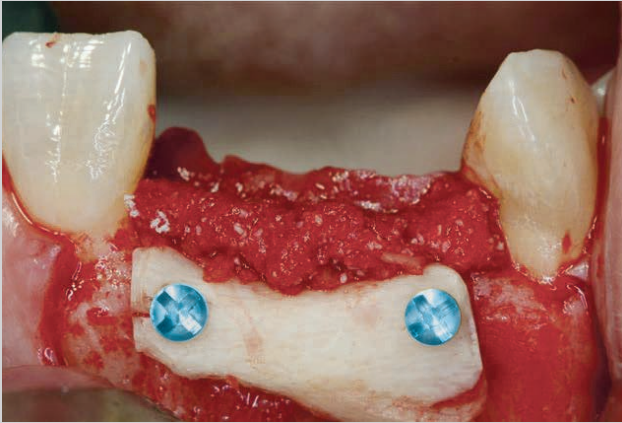

Foto: Dr. Stephan Beuer, M.Sc.



TITANIUM MICRO SCREWS

- diameter: 1,2 mm / 1,4 mm
- length: 6 mm / 8 mm / 11 mm / 13 mm

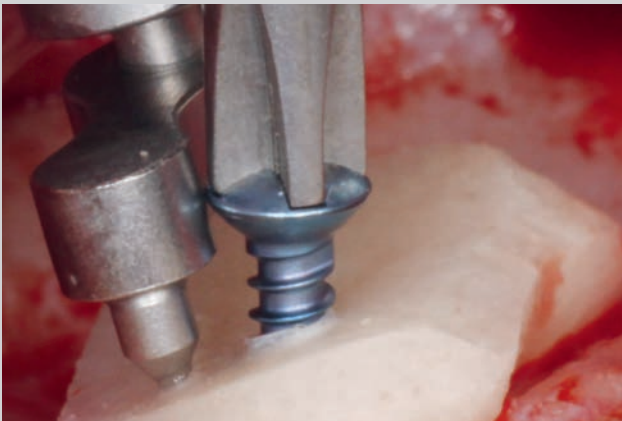
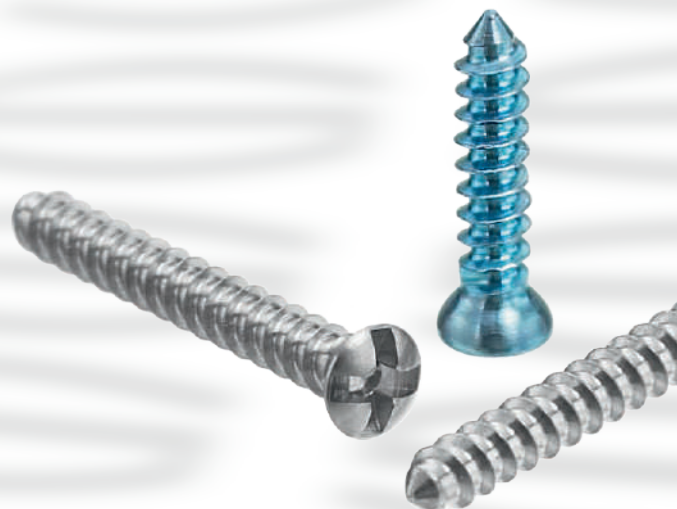
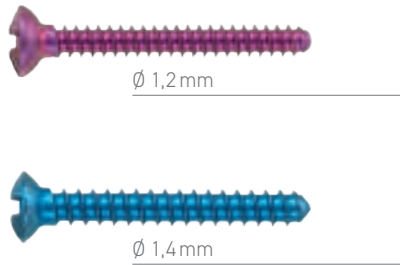

IMPLANT-STEEL ALLOY MICRO SCREWS

- diameter: 1,0 mm
- lengths: 8 mm / 11 mm / 13 mm
- perfectly suited for very small bone grafts and 3D-Augmentations
- special alloy material prevents Osseointegration and therefore a dramatically reduced danger of breaking the screws in comparison to titanium screws of similar lengths

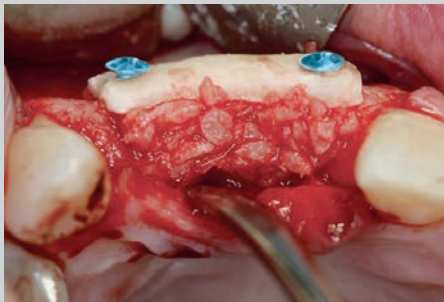
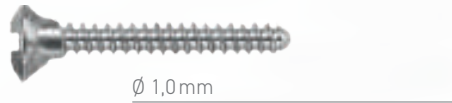

Photo: Jan Kielhorn

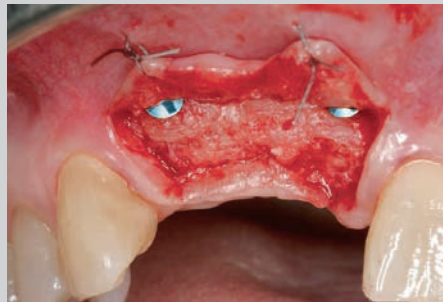

Photo: Jan Kielhorn

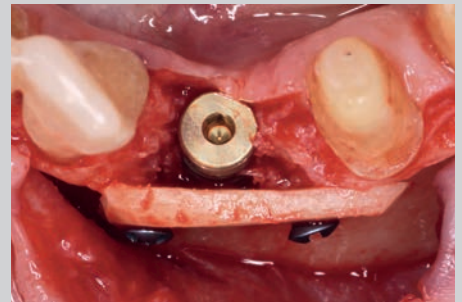

Photo: Dr. Stephan Beuer, M. Sc.



Photo: Dr. Stephan Beuer, M. Sc.

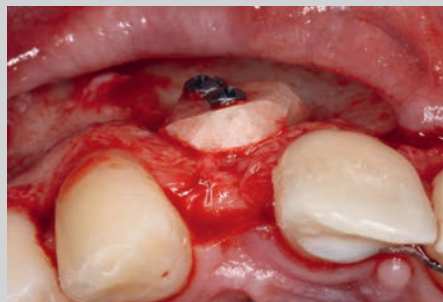

Photo: Dr. Stephan Beuer, M. Sc.

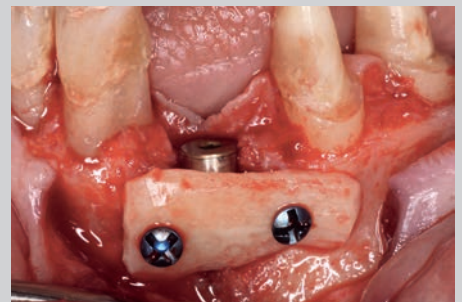
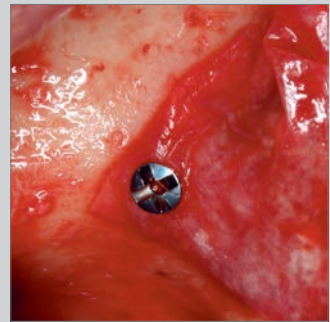
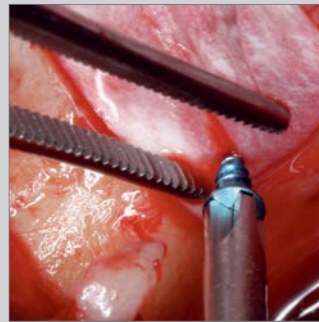
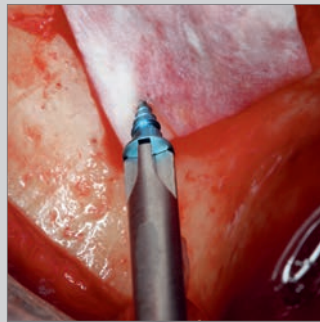
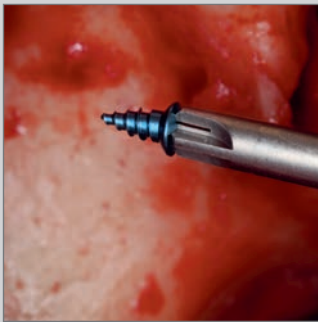
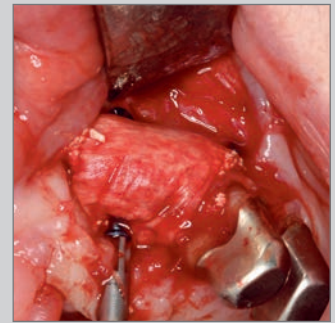
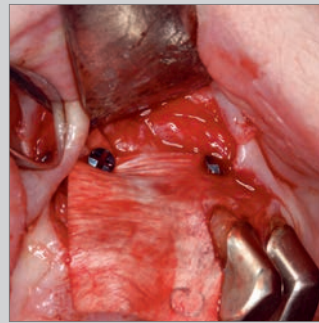
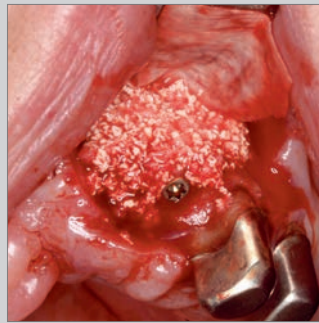
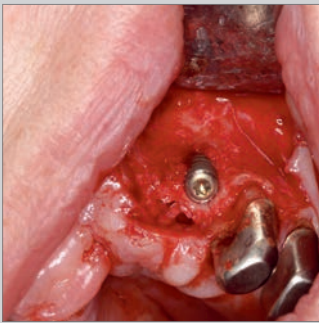

Photo: Dr. Stephan Beuer, M. Sc.



T-FIX MEMBRANE SCREW

- titanium
- conical threat
- lenght: 4 mm
- self-cutting/self-drilling, no pre-drilling
- perfect for applications in strong cortical bone
- for PTFE and titanium-reinforced membranes



∅ 1,5 mm, 10 pcs.

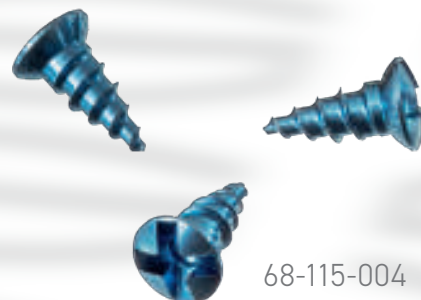

68-115-004

UMBRELLA-TECHNIQUE BY DR. DR. SCHLEE



IMPLANT-STEEL ALLOY

- diameter: 1,2 mm
- lengths: 8 mm / 11 mm / 13 mm
- screw head diameter: 5 mm
- no Osseointegration



highly-magnified presentation

68-780-014

Umbrella-Technique-Set



CONTENT:

- 68-720-010 Box for Umbrella-Screws
- 68-740-002 Screwdriver, 11cm, Fig.
- 68-760-102 Blade, cross, self-retaining, 60mm length, for 68-740-002
- 68-510-014 Pilot drill, Ø 1, 0mm, 14mm
- * 6x Umbrella Screw of choice

Umbrella Screw (packed individually)

- 68-112-208 S Steel, Ø 1, 2mm, 8mm length, cross
- 68-112-211 S Steel, Ø 1, 2mm, 11mm length, cross
- 68-112-213 S Steel, Ø 1, 2mm, 13mm length, cross

Accesso-

- 68-720-002 Box for Micro-Screws Ø 1,0/ 1,2/
- 68-740-002 Screwdriver, 11cm, Fig. 2
- 68-760-106 Blade, cross, self-retaining, short, for Contra-Angle

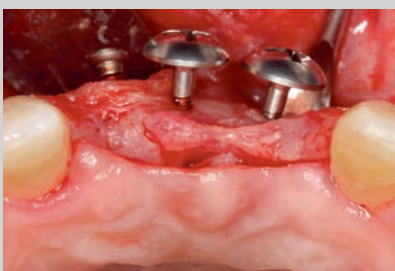
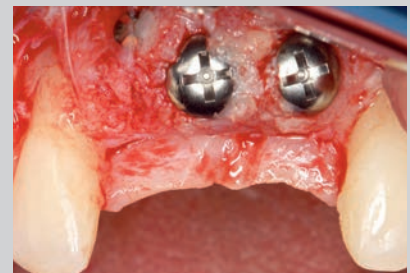

73





73-134-024

USTOMED, bur block, 12 x FG, 12 x RA



73-100-050

Needle and Drill sterilizing box, perforated, 50 x 25 x 4,5 mm



H: 8mm

73-100-065

Needle and Drill sterilizing box, perforated, 65 x 42 x 8 mm



73-106-065

Sterilizing box, unperforated, 65 x 42 x 8 mm



73-120-065

Needle and Drill sterilizing box, Ø 65 mm



73-124-062

Insert only, for box 73-120-065

73

Jars



73-200-002

Jar, Ø 50 mm, height 100 mm



73-200-003

Jar, Ø 50 mm, height 130 mm



73-251-250

Kidney bowl, 250 x 140 x 40 mm

1/2

INFO

User's favorite



73-290-025

Metal-Bowl, 25 cc

INFO

Heavy built,
for a safe stance



73-295-000

Graft-Bowl



73-292-050

Metal-Bowl, 50 cc,
graduated inside



73-294-125

Metal-Bowl, 125 cc



73-294-050

Metal-Bowl, 50 cc

79 CLEANING AND CARE

INFO

For maintenance of instruments prior to sterilization, for all instruments with joints, scissors, forceps, etc.



79-140-050

SURGI-STAIN, corrosion-ex,
Passivation Bath



79-130-040

USTOMED, oil spray, 500 ml,
biocompatible, sterilizable

80

EXTRACTING FORCEPS ENGLISH PATTERN



80

English Pattern, non-slip



80-001-000 HP

Figure 1, upper incisors and canines, wide



80-002-000 HP

Figure 2, upper incisors and canines



INFO

Reaches under the gingival margin

80-334-000 HP

Figure 34, upper incisors and canines, deep-gripping



1/1

80-007-000 HP

Figure 7, upper premolars



INFO
Reaches under the
gingival margin

1/1

80-335-000 HP

Figure 35, upper premolars,
deep-gripping

80

English Pattern, non-slip



80-017-000 HP

Figure 17, upper molars,
right



80-018-000 HP

Figure 18, upper molars,
left

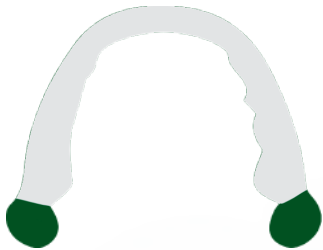

1/1

80-067-000 HP

Figure 67, upper third molars



1/1

80-067-001 HP

Figure 67A, upper third molars, narrow



1/1

80-051-000 HP

Figure 51, upper roots



1/1

80-051-001 HP

Figure 51A, upper roots,
narrow



1/1

80-051-012 HP

Figure 51L, upper roots,
longer

WITZEL



INFO

The 45° angle allows these forceps to be used for upper and lower roots



80-355-000

1/1

Special Forceps, very fine, upper and lower roots

80-397-000 HP

1/1

Figure 97, upper root fragments

STIEGLITZ



1/1

80-555-000

Special Forceps,
very fine for roots



1/1

17-717-135

Splinter forceps, angled,
diamond-coated



1/1

80-597-000

Figure 97, upper
root fragments

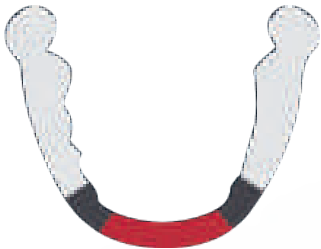

INFO
Reaches under the gingival margin



80-013-000 HP

Figure 13, lower incisors

80-013-001 HP

Figure 13A, premolars, narrow

80-336-000 HP

Figure 36, lower incisors and premolars, deep-gripping



80-022-000 HP

Figure 22, lower molars



80-022-019

Figure 22S, lower molars



80-086-001

Figure 86A, Cowhorn, lower molars

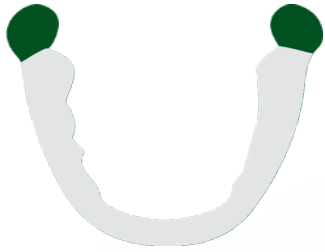

English Pattern, non-slip

80



80-079-000 HP

Figure 79, lower third molars, with tips



80-079-001 HP

Figure 79A, lower third molars



80-300-000

Special Forceps, upper and lower wisdom teeth

80

English Pattern, non-slip

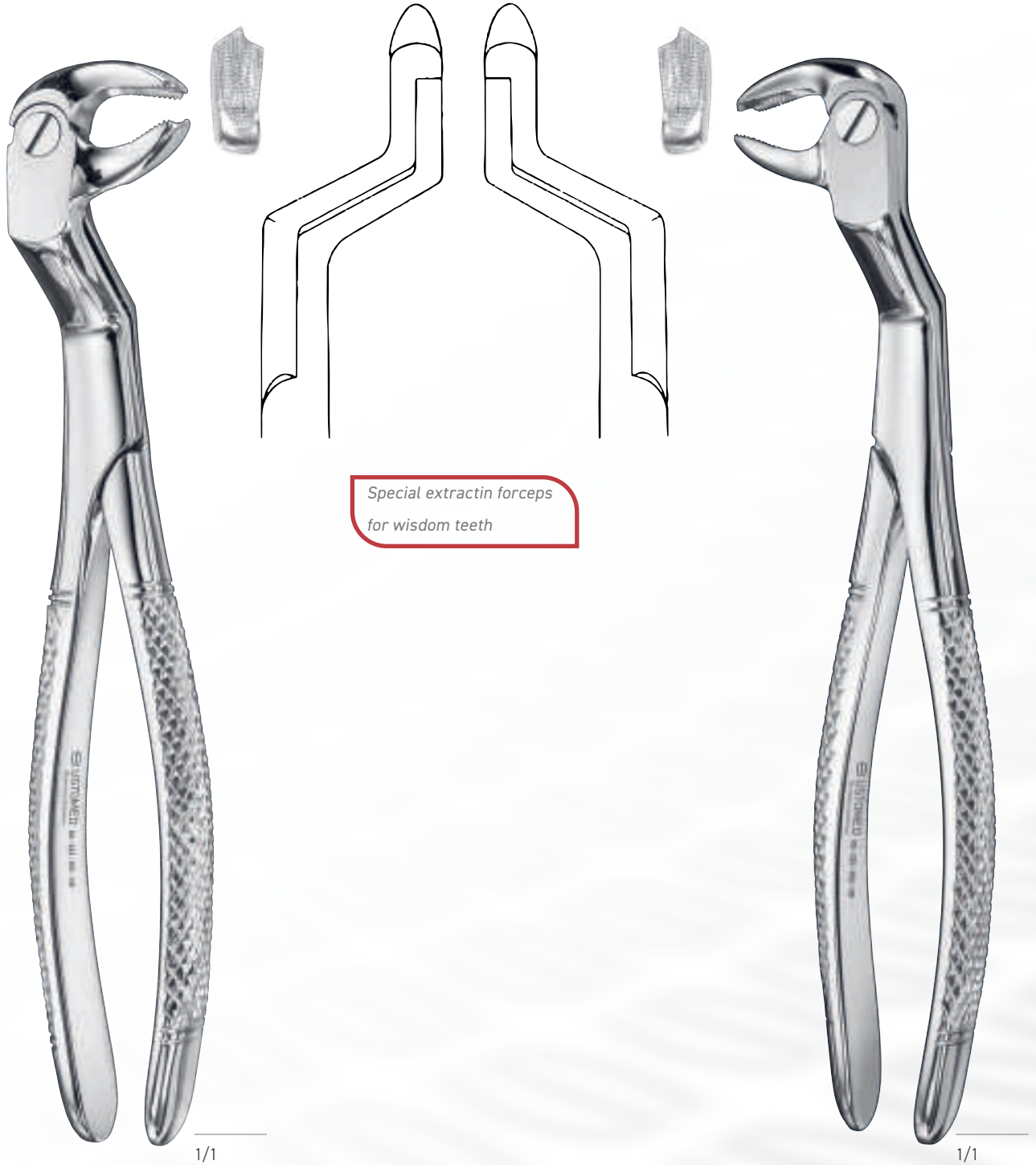
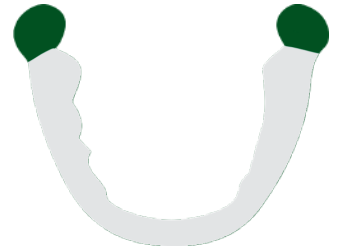

80-222-051 HP

Figure L, lower wisdom teeth,

80-222-052

Figure R, lower wisdom teeth, right



80-346-012 HP

Figure 46L,
lower roots

80-033-000 HP

Figure 33,
lower roots

80-033-001 HP

Figure 33A, lower
roots, narrow

80-033-012 HP

Figure 33L, lower
roots, longer

STIEGLITZ



17-717-135

Splinter forceps, angled,
diamond-coated



80-546-012

Figure 46L,
lower roots



80-555-000

Special Forceps,
very fine for roots

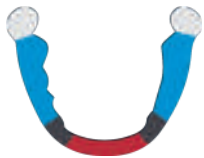

KLEIN

Extracting Forceps for Chil-

80



80-860-000
upper incisors



80-861-000
upper premolars



80-865-000
upper molars



80-863-000
upper roots



80-867-000
lower incisors



80-869-000
lower molars

80-860-006

complete Set, consisting
of 4 forceps upper jaw
and 2 forceps lower jaw

80-000-010

Basic Extraction Forceps Set



80-002-000HP
upper Front



80-007-000HP
upper premolars



80-017-000HP
upper molars



80-018-000HP
upper molars



80-067-000HP
upper 3rd molars



80-051-000HP
upper roots



80-013-001HP
lower Front/
premolars



80-022-000HP
lower molars



80-079-001HP
lower 3rd molars



80-346-012HP
lower roots

81 EXTRACTING FORCEPS WITH ANATOMICALLY SHAPED HANDLE



81

Anatomical Grip, non-slip



81-002-000 HP

Figure 2, upper incisors and



INFO
Reaches under the
gingival margin

81-334-000 HP

Figure 34, upper incisors and canines,
deep-gripping



81-007-000 HP

Figure 7, upper premolars



INFO

Reaches under the gingival margin

81-335-000 HP

Figure 35, upper premolars, deep-gripping



81-017-000 HP

Figure 17, upper molars, right



81-018-000 HP

Figure 18, upper molars, left

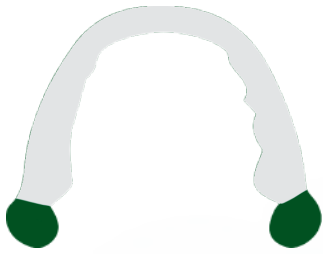

81-067-000 HP

Figure 67, upper third molars, bayonet



81-051-000 HP

Figure 51, upper roots, bayonet



81-051-001 HP

Figure 51A, upper roots, narrow, bayonet

81

Anatomical Grip, non-slip

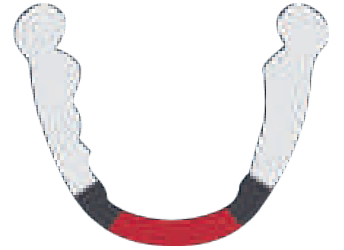

81-013-001 HP

Figure 13A, lower incisors, narrow



81-013-000 HP

Figure 13, premolars



81-336-000 HP

Figure 36, lower incisors and premolars, deep-gripping

INFO

Reaches under the gingival margin

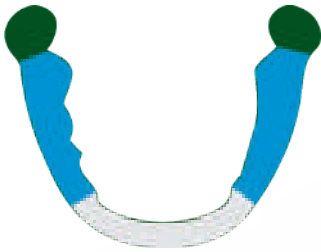

81-022-000 HP

Figure 22, lower molars



81-086-001

Figure 86A, Cowhorn,
lower molars



81-079-000 HP

Figure 79, lower third
molars, with tips

83

ROOT ELEVATORS



BEIN



1/1



1/1



1/1



1/1

83-100-002
straight, 2 mm

83-100-003
straight, 3 mm

83-100-004
straight, 4

83-100-005
straight, 5 mm

83

Root Elevators

BEIN



83-154-004

serrated, 4

1/1



1/1

83-111-025

curved backwards,
2,5 mm



1/1

83-111-035

curved backwards,
3,5 mm



1/1

83-111-045

curved backwards,
4,5 mm



1/1

83-117-035

modified, bayonet,
3,5 mm

USTO-LUX



83-120-003

straight, 3 mm, delicate

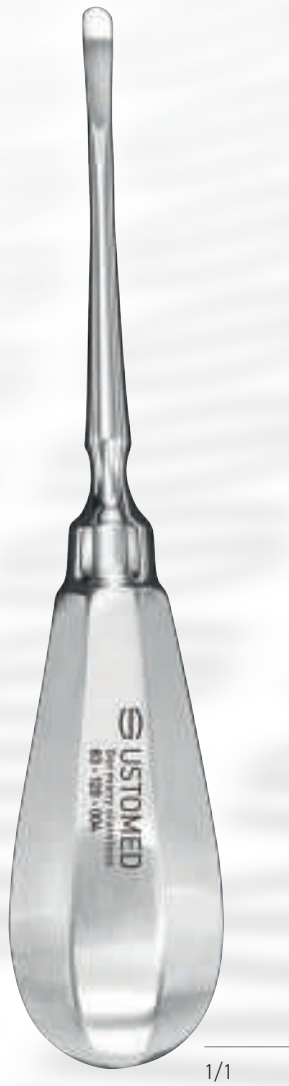

83-120-004

straight, 4 mm, delicate



83-120-005

straight, 5 mm, delicate

USTO-LUX



1/1

83-121-003

curved, 3 mm, delicate



1/1

83-121-004

curved, 4 mm, delicate



1/1

83-121-005

curved, 5 mm, delicate

FLOHR

CRYER



1/1



1/1



1/1



1/1

83-151-003
angled, size 3

83-151-004
angled, size 4

83-151-007
angled, size 7

83-151-008
angled, size 8

83

Root Elevators

HEIDBRINK



1/1

83-231-009
angled, size 9



1/1

83-230-008
straight, size 8



1/1

83-231-010
angled, size 10

CRYER

FLOHR



1/1

83-427-001
angled, right



1/1

83-427-002
angled, left



1/1

83-445-028
size 28, angled



1/1

83-445-027
size 27, angled

83

Root Elevators

WINTER



83-741-006
size 12R, cross handle

BARRY



83-761-321
size 321, cross handle



83-741-005
size 12L, cross handle



83-761-320
size 320, cross handle

MOD. WIEN



83-783-002

rotating elevator, 2 mm,
bayonet



83-783-003

rotating elevator, 3 mm,
bayonet



83-783-004

rotating elevator, 4 mm,
bayonet

83

Fragment Ejectors



1/1



1/1



1/1

STIEGLITZ



1/1

83-871-001

size 1,
double-ended

83-871-002

size 2,
double-ended

83-871-003

size 3,
double-ended

17-717-135

Splinter forceps, angled,
diamond-coated

83-871-001PO

size 1,
double-ended,
peek handle

83-871-002PO

size 2,
double-ended,
peek handle

83-871-003PO

size 3,
double-ended,
peek handle



1/1

83-904-000

size 0, straight,
hollow handle



1/1

83-905-002

size 2, angled,
hollow handle



1/1

83-899-002

size 2, angled,
octagonal
handle



1/1

83-905-001

size 1, angled,
hollow handle



1/1

83-899-001

size 1, angled,
octagonal handle



1/1

83-898-000

size 0, straight,
octagonal handle

84 BASIC INSTRUMENTS, MOUTH MIRRORS AND SYRINGES



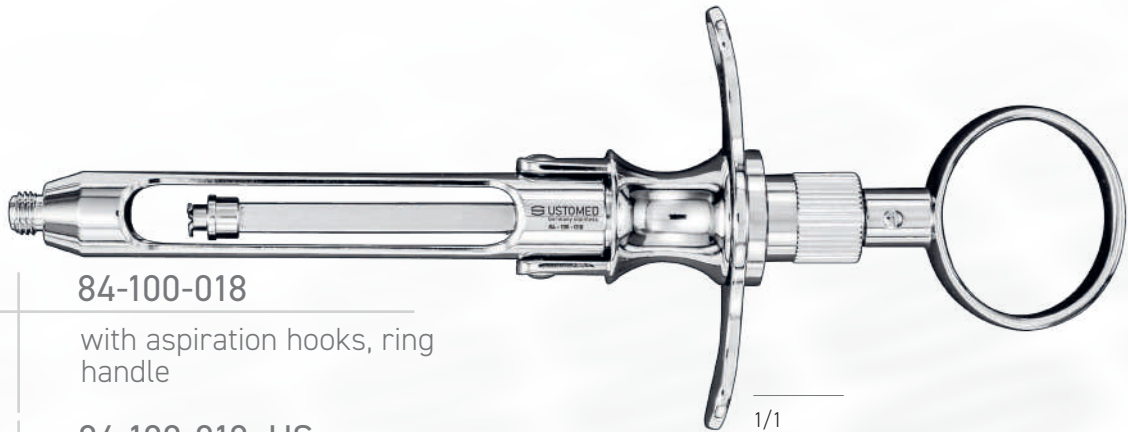

84-100-018

with aspiration hooks, ring handle

1/1

84-100-018_US

US-Standard Cartridge version

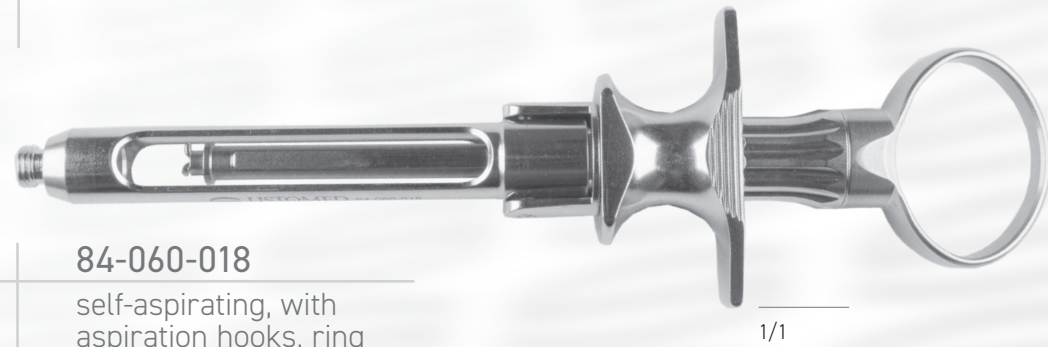

84-060-018

self-aspirating, with aspiration hooks, ring handle, stainless

1/1

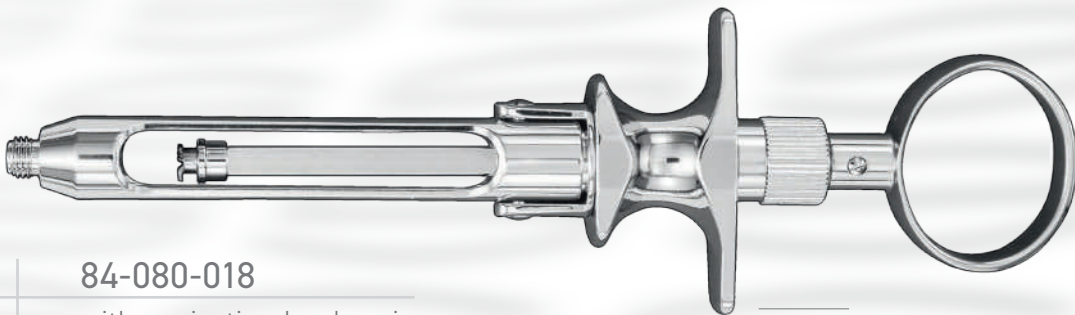

84-080-018

with aspiration hooks, ring handle, compact

1/1



84-116-018

Exchangeable Cartridge holder, aspiration hooks, ring handle

1/1

84

Intra-ligamental Cartridge Syringes

PAROJECT (RØNVIG)



84-149-000

Syringe with automated-pressure regulation
for intra-ligamental use



1/1

84-126-050

Spare attachment for
84-110-018 / 84-112-018



1/1

84-135-000

Ointment Cannulas,
pack of 10

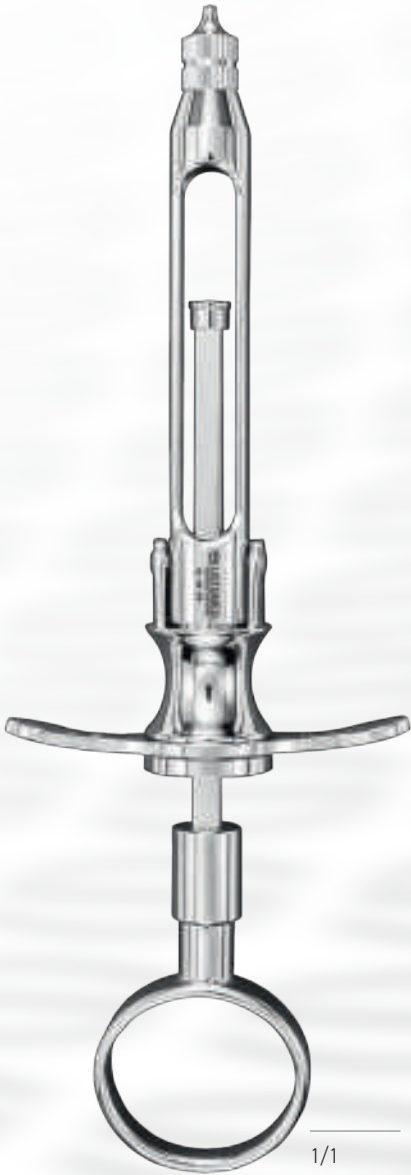

1/1

84-110-018

Self-aspirating, ring handle



1/1

84-161-001

Spare cannula, Ø 2,
0 mm, Luer-Lock

84

Mouth Mirror Handles



1/1



1/1



1/1



1/1



1/1

84-218-000

anatomical shape

84-220-000

solid, round shape

84-225-000P0

peek handle

84-225-000POT3

peek handle with metal rings

84-224-000

hexagonal shape, stainless-steel

86-080-000

Anatomical USTOMED handle, for probes and mirrors



	3 20 mm	4 22 mm	5 24 mm
plane		84-253-004	84-253-005
high-reflection (approx. 20%)		84-265-004	84-265-005
plane, Rhodium (no double pictures)	84-273-003	84-273-004	84-273-005

INFO
User's choice



84-224-004

Combined mirror/
cheek retractor,
plane, Size 4

INFO

In contrast to conventional mirrors, Rhodium front-surface mirrors have the reflecting metal coating applied to the surface of the mirror plate resulting in a **sharply** defined **refraction-free** image.

84

Root Resection Mirrors



1/1

84-285-003POT3

plane, Rhodium,
Ø 3 mm



1/1

84-285-005POT3

plane, Rhodium,
Ø 5 mm



1/1

84-285-062POT3

plane, Rhodium,
6x3 mm



84-990-000

Napkin holder



1/2

84-295-170

Mirror for buccal site



1/2

84-292-210

Mirror for lingual site

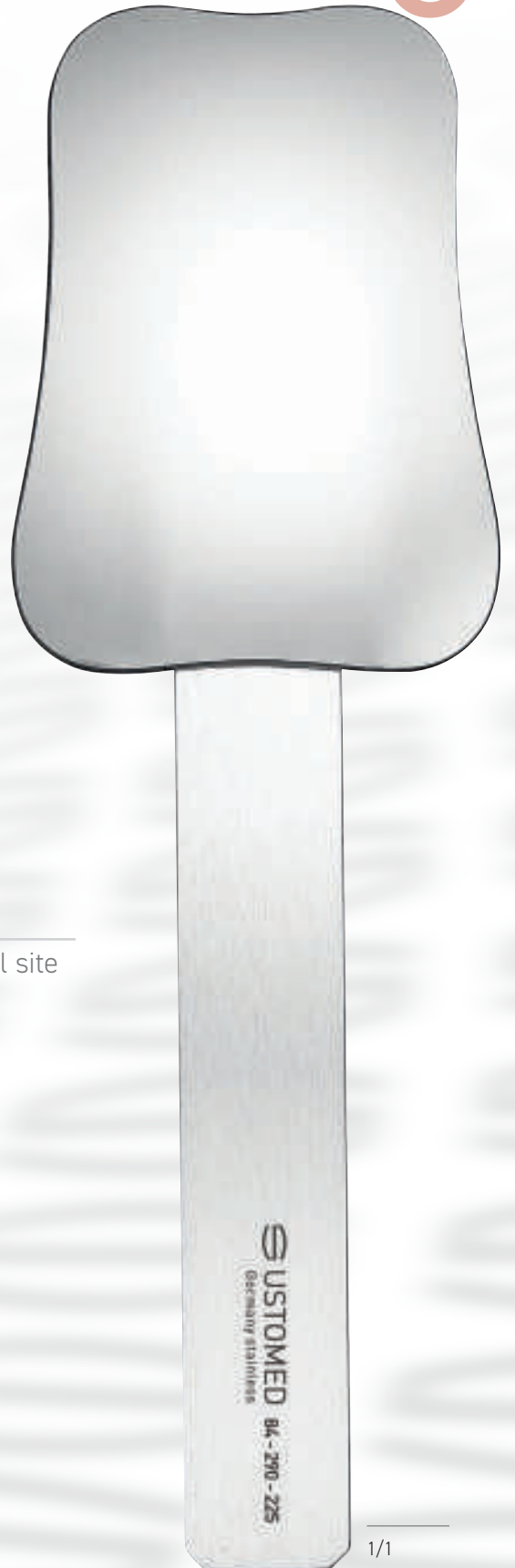

1/1

84-290-225

Mirror for occlusal site



84-296-300

Mirror Set (3 pcs.)

85

PERIODONTICS



CUMINE



85-071-001
Size 1



85-071-002
Size 2



85-071-003
Size 3



85-197-000
Rheinwald lifter

85

Excavators

2mm

WHITE



1/1



1/1

85-321-017

Size 17,
double-ended

85-321-017P0

Size 17,
double-ended,
Peek Griff



1/1

85-321-018

Size 18,
double-ended

85-321-018P0

Size 18,
double-ended,
Peek Griff



1/1



1/1

85-327-128

Size 127/128,
double-ended

85-327-128P0

Size 127/128,
double-ended,
Peek Griff



1/1

85-327-130

Size 129/130,
double-ended

85-327-130P0

Size 129/130,
double-ended,
Peek Griff

85-321-005

Size 5, double-ended

85-321-005P0

Size 5, double-ended,
peek handle

85-327-126

Size 125/126, double-ended

85-327-126P0

Size 125/126, double-ended,
peek handle

UNIVERSITY NORTH CAROLINA

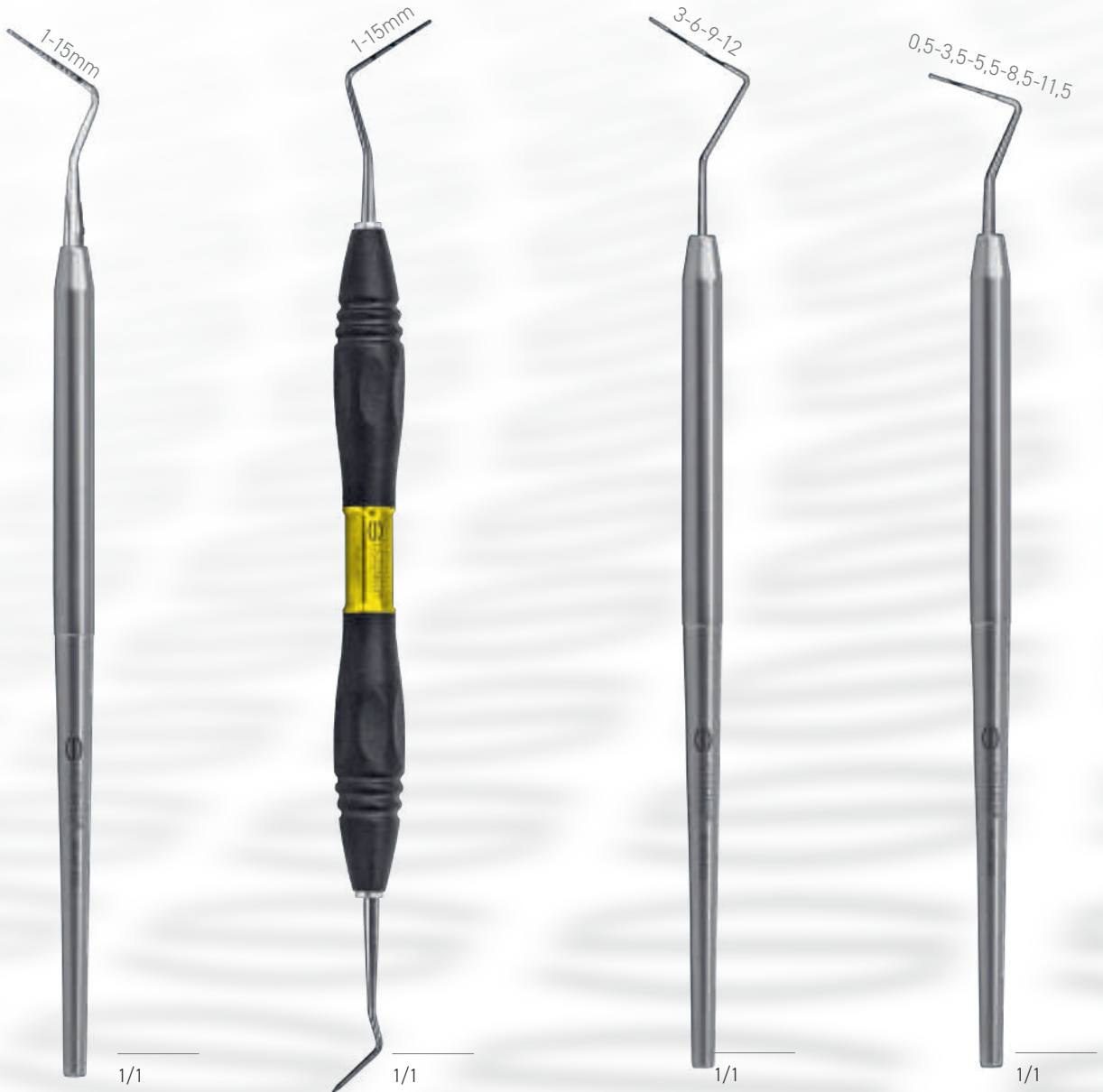

85-691-015

CP15,
colour marking

85-691-015 P0

CP15, peek handle

85-691-115P0T3

CP15 double-ended
with Probe

85-695-012

CP 12, colour
marking

85-695-012P0

CP 12, colour
marking, peek
handle

85-697-000

PSI/WHO,
colour marking

85-697-000P0

PSI/WHO, colour
marking, peek
handle

NABERS

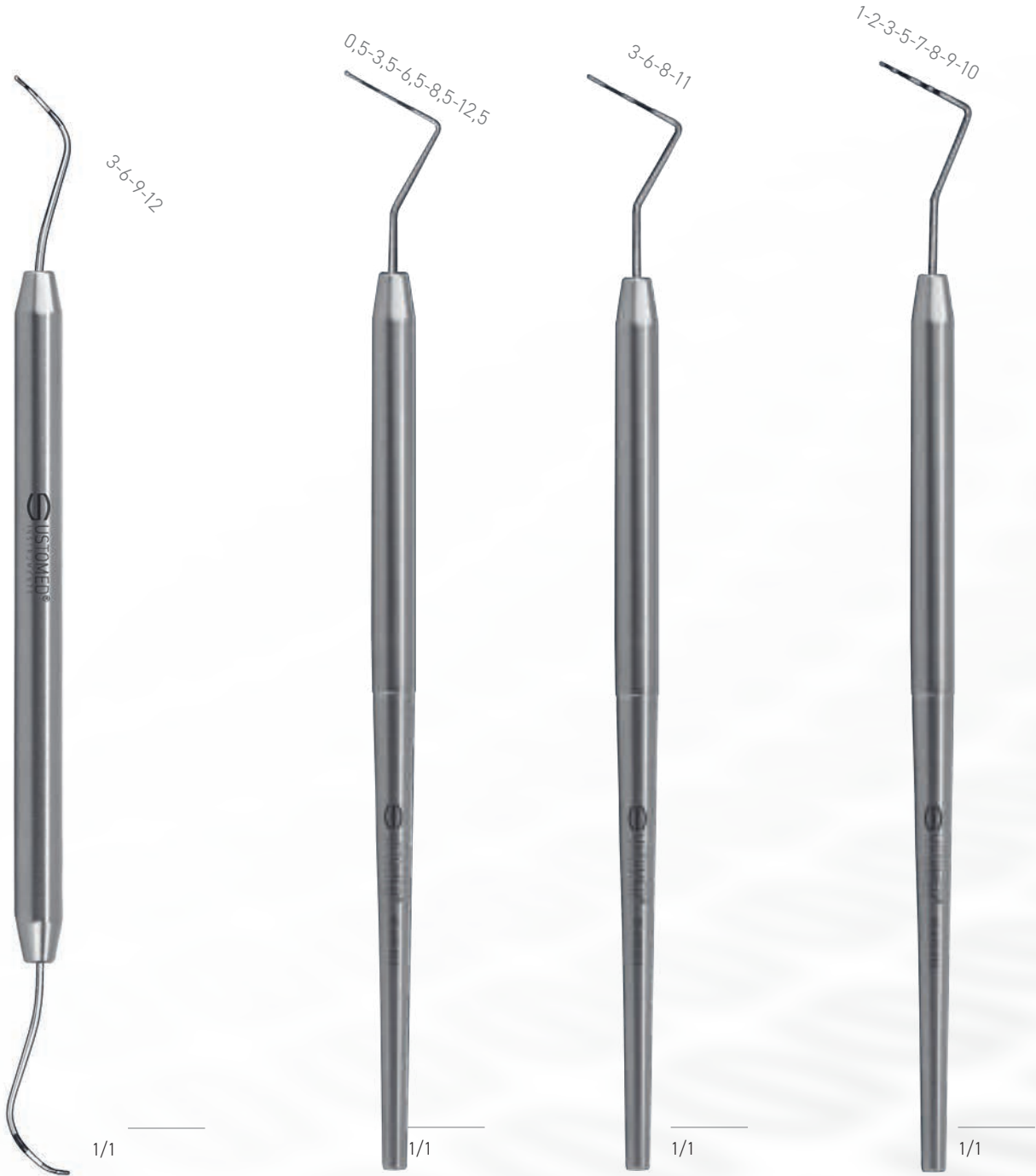

85-691-012

Q2N, probe,
colour marking

85-699-012

CP12 modified,
colour marking,
with tall tip

85-695-011

CP 11, colour
marking

85-693-010

CP 10, colour
marking

TAYLOR

INFO
User's choice



1/1

85-745-023

M 23, double-ended, universal



1/1

85-757-204

204 SD, double-ended



1/1

85-735-023

T2/T3, double-ended



1/1



1/1



1/1



1/1

85-749-067

H6/H7, slight angulation, double-ended



1/1

85-741-023

CI 2/3, double-ended



1/1



1/1

85-755-204

204 S, double-ended

85

Peek Scaler



85-781-056POT3

Curette, 5/6, Peek handle

85-779-056P7T3

Curette, 5/6, Peek,
pink, DLC coat



85-781-078POT2

Curette, 7/8, Peek handle

85-779-078P7T2

Curette, 7/8, Peek,
pink, DLC coat



85-781-112POT4

Curette, 11/12, Peek handle

85-779-112P7T4

Curette, 11/12, Peek,
pink, DLC coat



85-781-134POT1

Curette, 13/14, Peek handle

85-779-134P7T1

Curette, 13/14, Peek,
pink, DLC coat



85-719-067POT6

Scaler, H6/H7,
Peek handle

85-729-204POT5

Scaler, 204 S, Peek
handle

85-729-204PO

Scaler, 204 S, Peek
handle, DLC coating



91-321-006

Perio Set Peek



91-321-005

Perio Set Peek,
pink, DLC coating

85

GRACEY (ONE SIDED SHARP)



1/1

85-781-034

3/4, double-ended



1/1

85-781-056

5/6, double-ended



1/1

85-781-078

7/8, double-ended



1/1

85-781-012

1/2, double-ended



1/1

85-781-091

9/10, double-ended



1/1

85-781-112

11/12, double-ended



1/1

85-781-134

13/14, double-ended

85

Periodontal Curettes

COLUMBIA



85-787-004

Curette, 4L/4R,
double-ended, universal

MC CALL



85-789-178

Curette, universal, 17/18,
double-ended

LANGER



INFO

*Titanium tips for
cleaning of implant
surfaces*

85-795-056

Curette, 5/6, titanium,
double-ended, both-sided
sharp

85-795-056POT3

Curette, 5/6, titanium,
double-ended, both-sided
sharp, peek handle

ZUCCHELLI

INFO

black coated tips, allow better visuability under gingiva



85-814-175POT3

 Mod. Z, peek handle

85-812-175POT3

Mod. W, peek handle

85-812-175

Mod. W

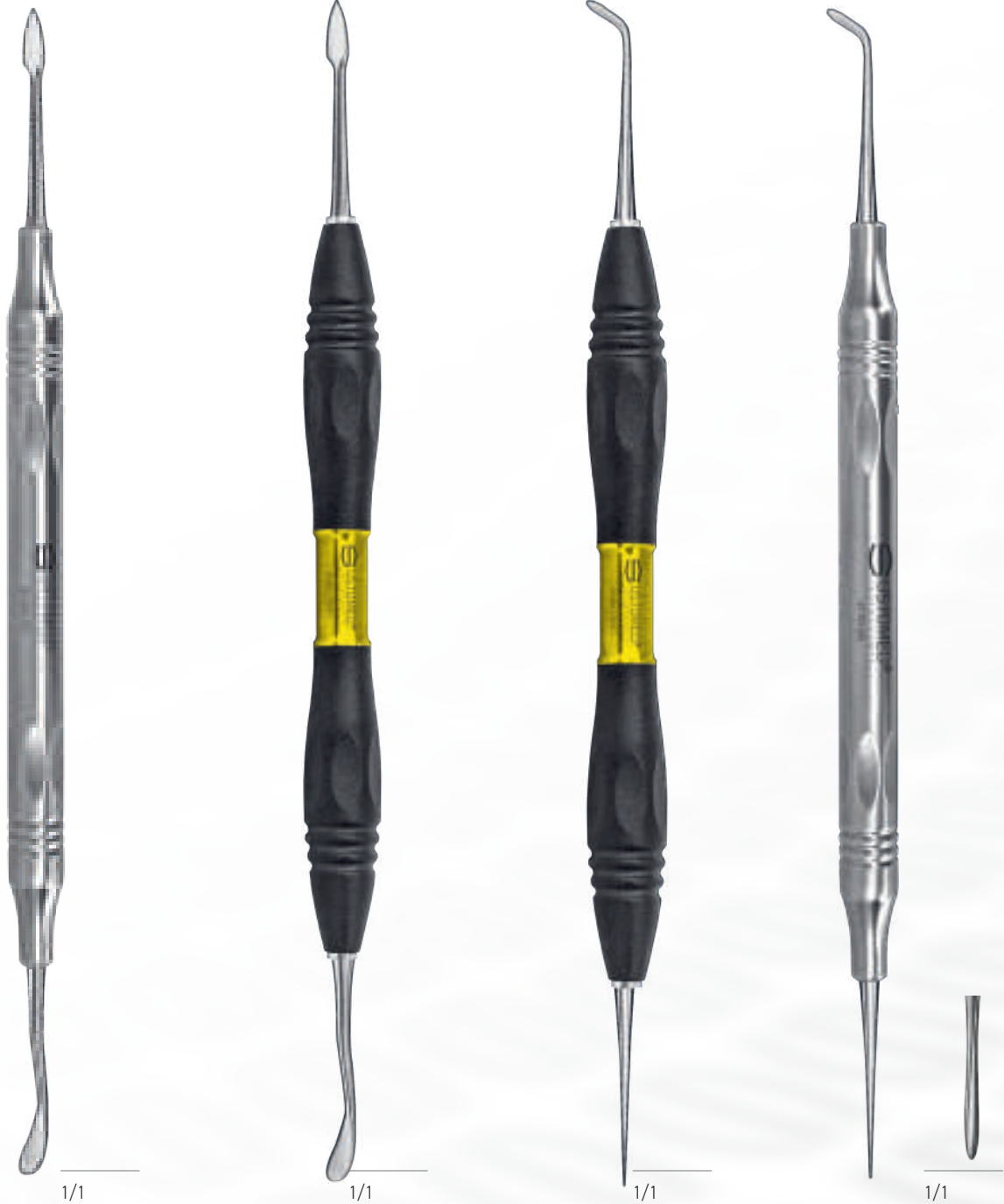

85-816-175

Raspatory Mod. B

85-816-175POT3

Mod. B, 17,5 cm,
peek handle

85-808-175POT3

Mod. W, 17,5 cm,
peek handle

85-808-175

Mod. W, 17,5 cm

KASAJ

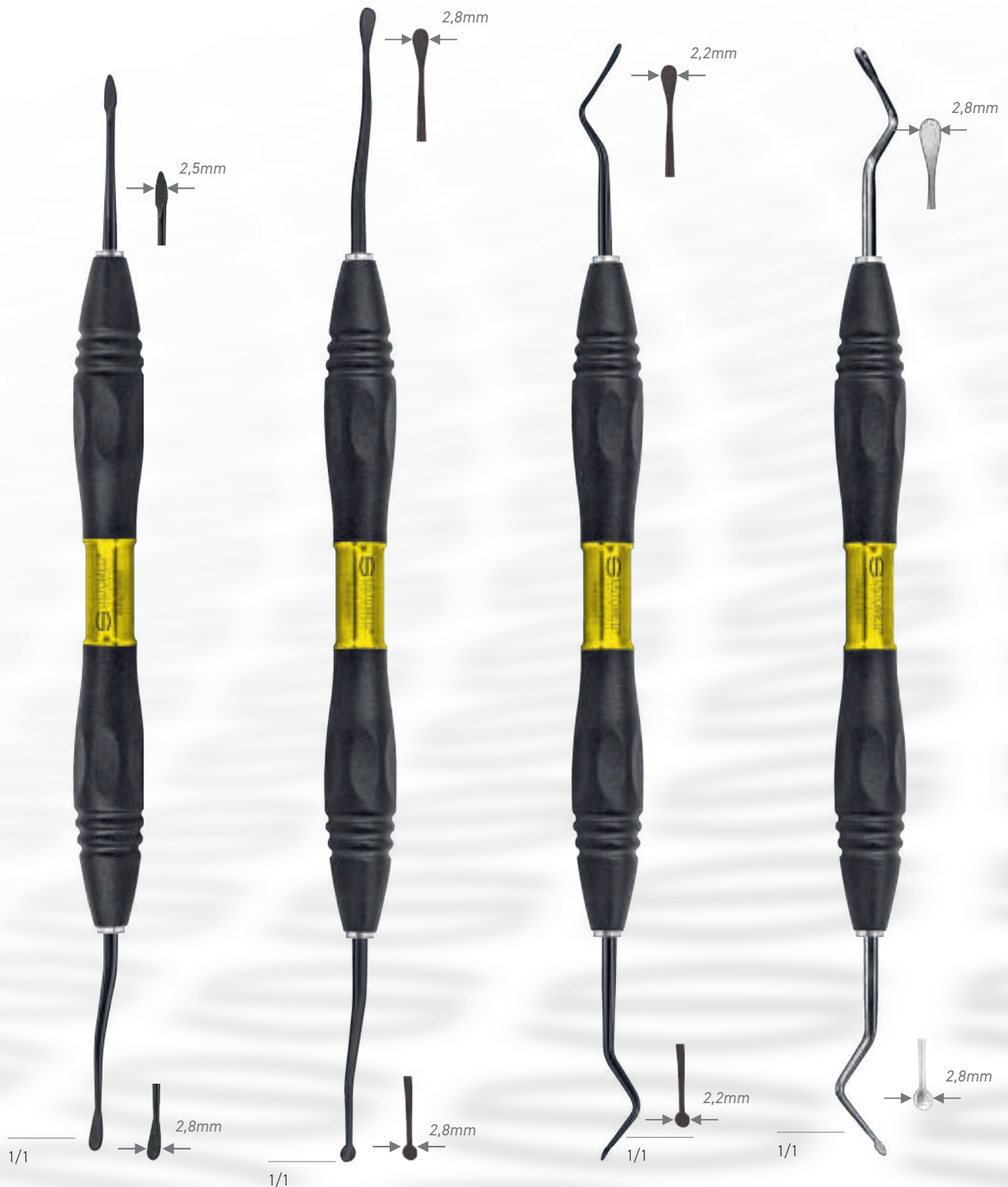

85-816-170 P0T3

Mod. B, micro

85-818-001P0T3

Tunnelling knife,
micro, 20cm,
posterior, peek
handle

85-818-002P0T3

Tunnelling knife,
micro, 19cm,
anterior, peek handle

85-818-175 P0T3

Tunneling knife,
19 cm, anterior,
peek handle

ORBAN



1/1

85-831-012P0T3

Tunneling knife, 19 cm, anterior, peek handle

KIRKLAND



1/1

85-825-156P0T3

Gingivectomy knife, double-ended, peek handle

86 HAND INSTRUMENTS



86

Probes and Explorers, single-ended

ROUND HANDLE



1/1

86-153-001

Size 1

86-153-001P0

Size 1, peek handle



1/1

86-153-017

Size 17



1/1

86-153-044

Size 44



1/1

86-157-001

Size 1,
extra fine



1/1

86-157-017

Size 17,
extra fine



1/1

86-157-044

Size 44,
extra fine

86

Probes and Explorers, double-ended



86-213-002

Furcation Probe,
unscaled



86-223-003

Size 3



86-211-002

Probe, extremely
fine points



INFO
User's choice

86-350-001
Size 1

86-350-002
Size 2

86

Filling Instruments

Plugger, double-ended, ball



86-521-001

Size 1

86-521-001P0



86-521-002
86-521-002 P0

Size 2



86-521-003
86-521-003P0

Size 3



86-521-004
Size 4



86-521-005
Size 5



86-521-000
Size 0



HEIDEMANN

flexible/semi-sharp



86-721-001P0

Size 1, peek handle

86-721-001

Size 1

86-721-002P0

Size 2, peek handle

86-721-002

Size 2

86-721-003P0

Size 3, peek handle

86-721-003

Size 3

86

Filling Instruments

Spatule (rigid/blunt), double-ended

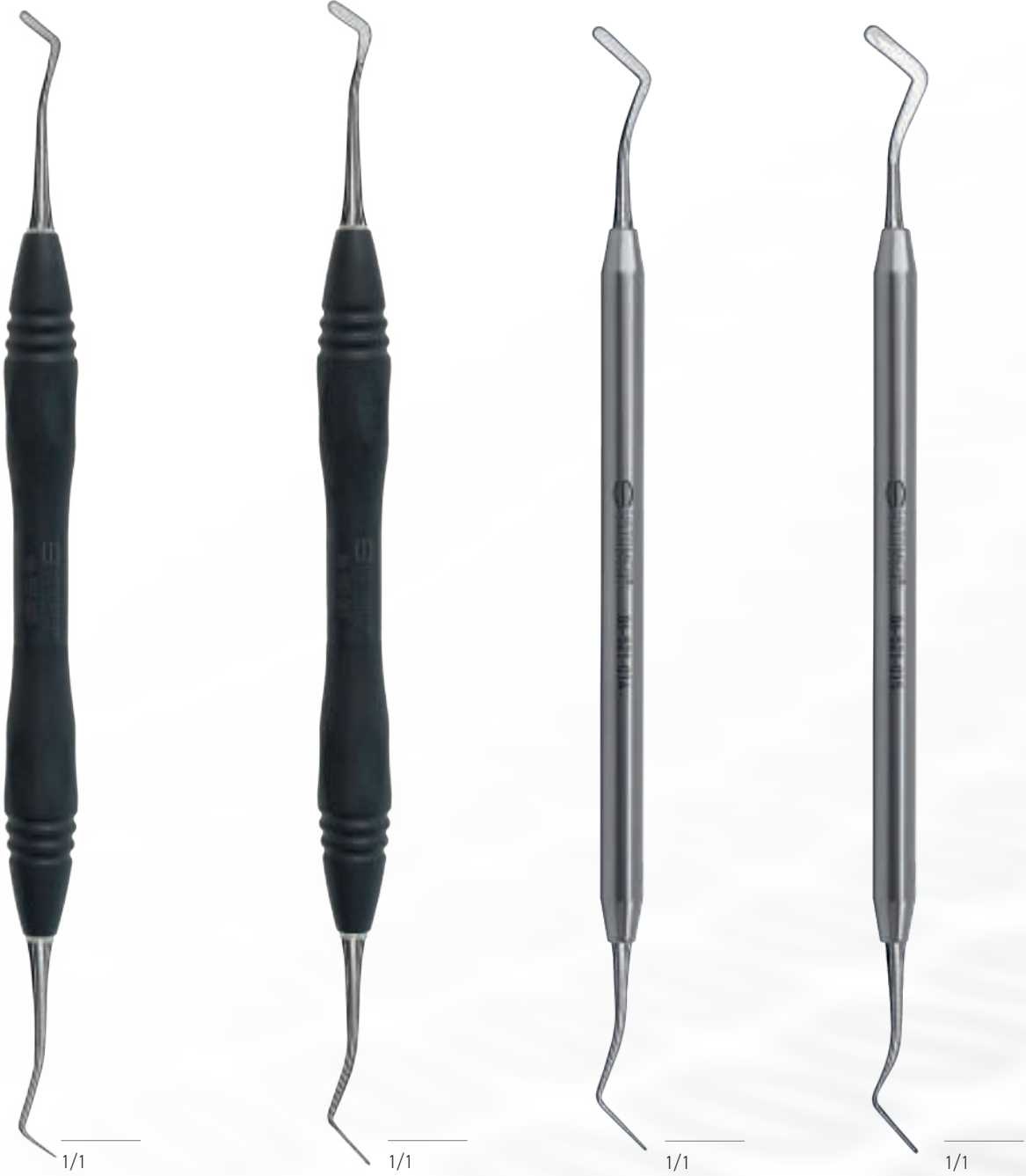

86-551-000P0

Size 0, peek handle

86-551-000

Size 0

86-551-001P0

Size 1, peek handle

86-551-001

Size 1

86-521-014

Size 14

86-521-015

Size 15

Plugger (pear-shaped), double-ended



1/1

86-521-017

Size 17



1/1

86-521-019

Size 19



Plugger (plain), double-ended



1/1

86-521-035

Size 35



1/1

86-521-036

Size 36



1/1

86-521-037

Size 37



Planisher, double-ended



1/1

86-521-061

Size 61, small



1/1

86-521-062

Size 62, medium



1/1

86-521-063

Size 63, large



1/1

86-521-018

Size 18

86

Composite Instruments

INFO
Tips are
Titanium-
Nitrate-
coated



86-589-003

3TN

87

Prosthetics



87

Retrograde Filling Instruments

R(H)EINSTOPFER

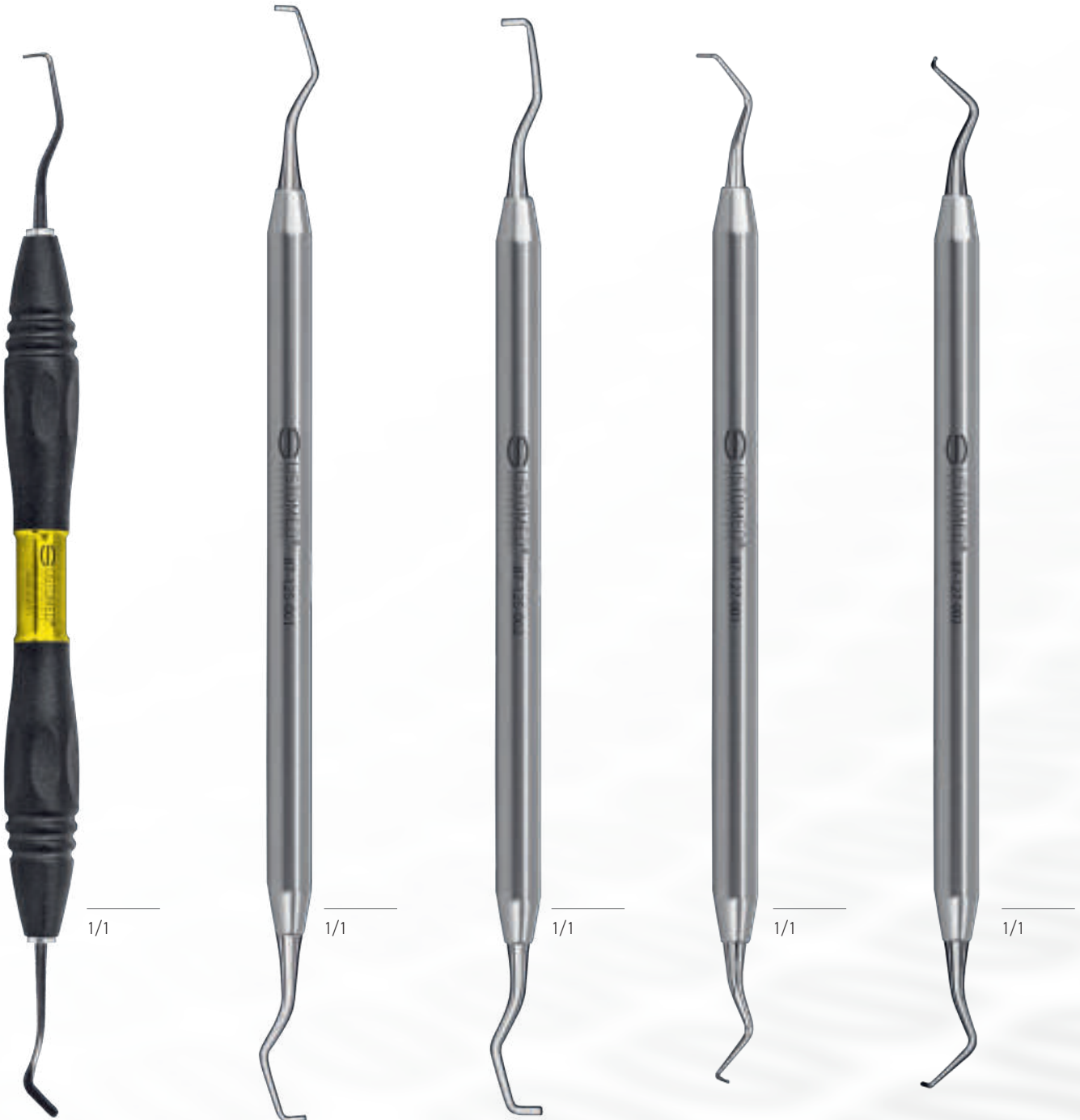

86-521-012P0T3

Size 2 retrograde
and Size 1
regular, peek
handle

87-125-001

Size 1,
double-
ended, peek
handle

87-125-002

Size 2,
double-ended,
peek handle

87-127-001

Mod. K,
Size 1, peek
handle

87-127-002

Mod. K,
Size 2, peek
handle

FAHNENSTOCK



1/1

Wax Knife

87-290-130

13 cm

87-290-175

17,5 cm

AINSWORTH



1/1

87-420-000

Rubberdam Punch, 17 cm



87-573-000

UNIVERSAL, crown spreader



87-570-000

Crown Spreader,

TOFFLEMIRE



87-344-001

1/1

Matrix Band, Size 1, 12 pcs



87-344-002

1/1

Matrix Band, Size 2, 12 pcs



87-344-003

1/1

Matrix Band, Size 3, 12 pcs

TOFFLEMIRE- UNIVERSAL



1/1

87-340-000

Matrix Retainer

TOFFLEMIRE-JUNIOR



1/1

87-340-001

Matrix Retainer

TOFFLEMIRE-SENIOR



1/1

87-340-002

Matrix Retainer

87

Crown Remover and Spreader

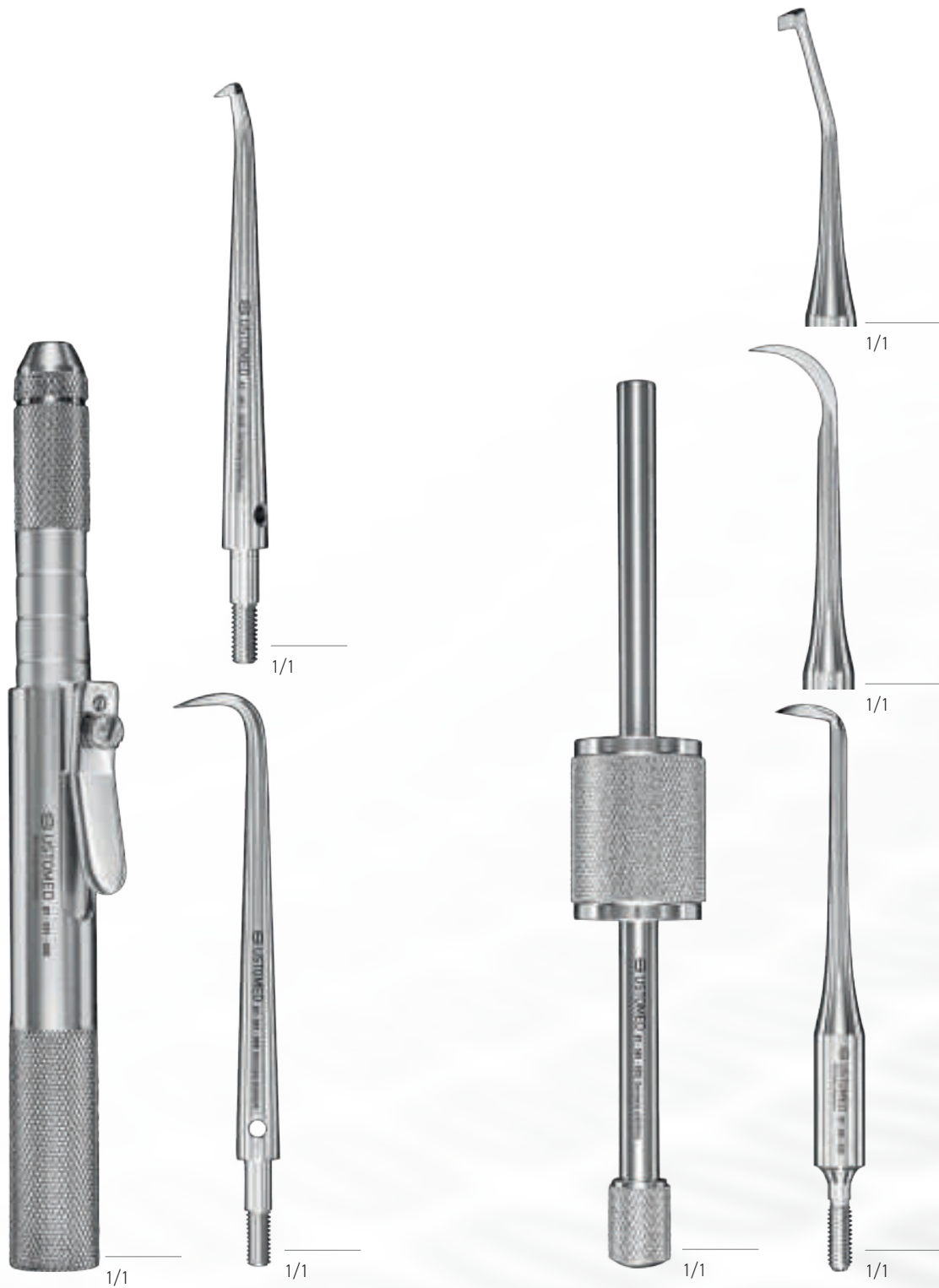

87-591-000

Crown/Bridge remover, semi-automatic,
incl. 2 Attachments

87-581-003

Crown Remover, incl. 3

88 IMPRESSION TRAYS



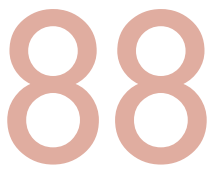

Impression Trays

Upper Jaw, perforated



Lower Jaw, perforated



88-100-000	88-100-003
Size 0	Size
88-100-001	88-100-004
Size 1	Size 4
88-100-002	
Size 2	

88-116-000	88-116-003
Size 0	Size 3
88-116-001	88-116-004
Size 1	Size 4
88-116-002	
Size 2	

Upper Jaw, rim-type



88-300-001 Size S	88-300-004 Size XL
88-300-002 Size M	88-300-005 Size XXL
88-300-003 Size L	

Lower Jaw, rim-type



88-310-001 Size S	88-310-004 Size XL
88-310-002 Size M	88-310-005 Size XXL
88-310-003 Size L	

SCHEUFELE



88-240-001
Occlusion Tray, small



88-240-002
Occlusion Tray, large

89

PROSTHETICS





1/1

89-120-140

FURRER,
pliers, remov.
provis.a.copper ring



1/1

89-115-140

CROWN TRACTOR,
complete with 10 pcs.
Spare jaws and 10 g
adhesive powder



89-115-020

Exch. spare jaws,
synthetic, pack.
20ea.



89-115-010

Phiaal, cont. 10 g
adhesive powder



89-140-010

DEGIDI, Cono Grip,
silicone pads,

DEGIDI



89-140-011

DEGIDI Cono Grip,
upper jaw, delicate



89-140-023

DEGIDI Cono Grip,
lower jaw



1/1

89-179-002

Diamond inserts,
only, 2 ea. pack.



89-179-

Allan key, only



89-179-125

BÖHM, telescope crown
pliers, diamond tips, incl.
Allen key and tips

ADERER



89-554-140

cross-cut jaws



89-370-115

ADERER, wire and clasp
bending pliers

89-260-160

UNIVERSAL, pin rough.,
cutt.and bend.plier



89-752-130

Mixing bowl of soft silicone, Ø 13 cm



89-720-190

Plaster and laborat.spatula,
elastic bla.

90 STORAGE, ORGANISATION AND STERILIZATION





90-200-000

Norm-Tray Cassette, Full-Size, unperforated



90-204-000

Norm-Tray Cassette, Full-Size, perforated bottom



90-210-001

Unperforated Lid, only

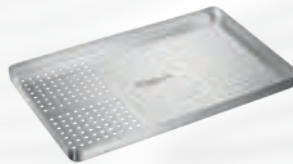

90-218-001

Perforated Bottom, only



90-304-000

Norm-Tray Cassette, Demi-Size, perforated bottom

90-214-001

Unperforated Bottom, only



90-230-000

Storing Frame, Y-type, Full-Size

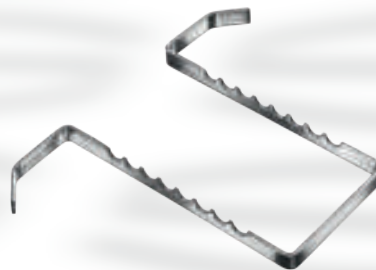

90-330-000

Storing Frame, Y-type, Demi-Size



90-126-100

Paper Filters for Norm-Trays
(250 pcs/pack)

90

Organization

INFO

Storing Trays for an optimal Organization of Hand Instruments during Cleaning, Sterilization and Storage.
 Advantage: Tips of instruments are being saved and it speeds up the processing.



90-340-004

Storing Tray, Quarter-Size, for 4 instruments (Mirror, Probe, Perio Probe, Tweezers)



90-340-005

Storing Tray, Quarter-Size, for 5 instruments



90-340-008

Storing Tray, Demi-Size, for 8 instruments

INFO

Fits the Demi Container
 90-628-040



90-340-010

Storing Tray, Demi-Size, for 10

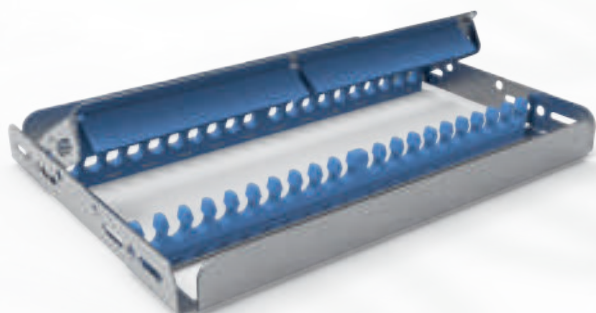

90-340-020

Storing Tray, Full-Size, for 20 instruments

Tray item number +

S0	black
S1	Blue
S2	Green
S3	Yellow
S4	Red
S5	Grey
S7	Violet
S9	Orange
S10	White

INFO

For storage of Sterile Sets



90-620-040

Sterilization Container, Full-Size, 4 cm
315 x 190 x 40mm

90-620-065

Sterilization Container, Full-Size, 6,5 cm
315 x 190 x 65mm



90-618-100

Sterilization Container, Full-Size, 10
315 x 190 x 100mm

90-618-130

Sterilization Container, Full-Size, 13 cm
315 x 190 x 130mm

INFO

Accessoires for Container
on page 205!

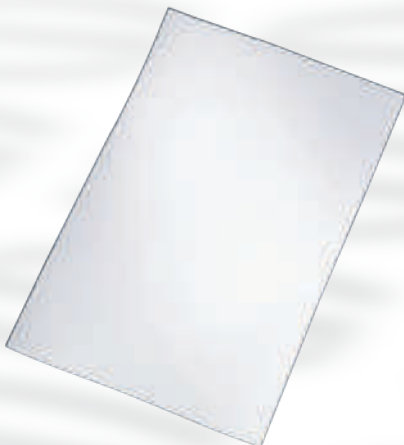

**Customized
Teflon-Filter**

90-643-001

Teflon-Filter, for series
90-620-xxx

90-642-001

Teflon-Filter, for series
90-618-xxx

90

Sterilization



INFO

Sterilization Container with permanent filter!



DENTAL STERILIZATION-CONTAINER SYSTEM WITH SAFETY-FILTER

Ustomed's answer to consistently increasing demands for risk minimization, environmental protection and handling comfort, is the newly-developed Easy-Stop System.

The filterless mechanism stops microorganisms even more effectively than conventional filter systems and can be re-used as often as you like. There is no need for consumable purchasing.

To open or close, one handling step is enough:

Simply, press the lid down, and turn!

THE ADVANTAGES SPEAK FOR THEMSELVES:

- The unique lid is almost indestructible: It is precision-milled from a solid block of aluminum. That way, the lid stays in shape and can withstand the daily office routines.
- Dirt- and germ-repellent
- Fast and residue-free drying during steam-sterilization
- High quality material for triple safety: adhere-free, pore-free and corrosion-free

INFO:

The two-piece aluminum insert in the lid serves as a germ barrier according to the principle of the „Pasteur Loops“. By forming a labyrinth of ring ribs, it therefore reliably separates microbes, germs and particles.

The meandering flow path achieves a decontamination rate of 99.997%

90-626-040

Sterilization Container, Full-Size, Pasteurian Loops, 4 cm

315 x 190 x 40mm

90-626-065

Sterilization Container, Full-Size, Pasteurian Loops, 6,5 cm

315 x 190 x 65mm

90-626-085

Sterilization Container, Full-Size, Pasteurian Loops, 8,5 cm

315 x 190 x 85mm

90-628-040

Sterilization Container, Demi-Size, Pasteurian Loops, 4 cm

195 x 145 x 40mm

90-628-065

Sterilization Container, Demi-Size, Pasteurian Loops, 6,5 cm

195 x 145 x 65mm





**Ustomed
Teflon-Filter**

90-643-001

Teflon-Filter, for series 90-620-xxx

90-642-001

Teflon-Filter, for series 90-618-xxx

**Marking Plates,
including labeling**

(max. 16 characters)



90-650-000

Red



90-650-001

Blue



90-650-002

Green



90-650-003

Yellow



90-650-004

Black



90-650-005

Silver



90-650-007

Purple



90-650-008

Orange



90-665-100

Sealing Plombs with indicator fields (100 pcs/pack)

or

90-665-101

Sealing Plombs (1000 pcs/pack)



90-654-000

Identification Label, HIBC, Data Matrix

or

90-656-000

Identification Label, HIBC, Code 128

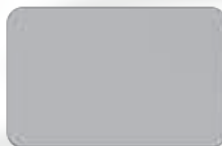

90-655-000

Plate for Stickers



90-662-100

Indicator Labels (100 pcs/pack)



90-716-001

Wash Basket, Full-Size, MK 4, cross-wise

90-716-002

Wash Basket, Full-Size, MK 4, longitudinal racks

90-716-000

Wash Basket, Full-Size, MK 4



90-716-050

Wash Basket, Demi-Size, MK 4,
for 90-628-040

90-716-065

Wash Basket, Demi-Size, MK 4,
for 90-628-065

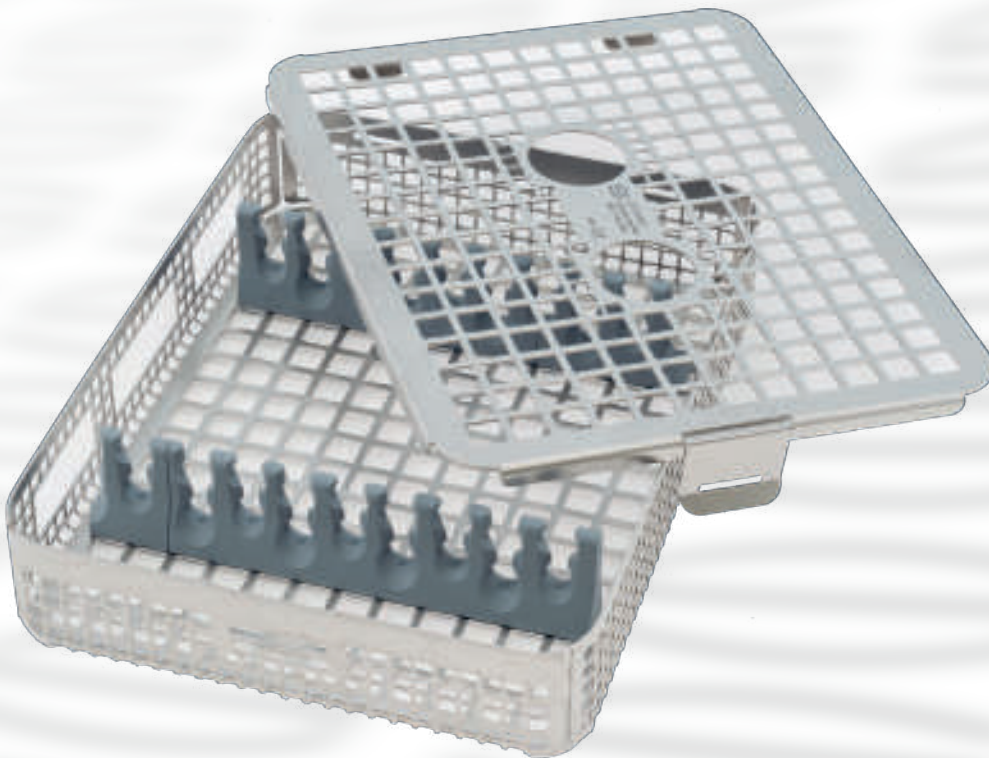
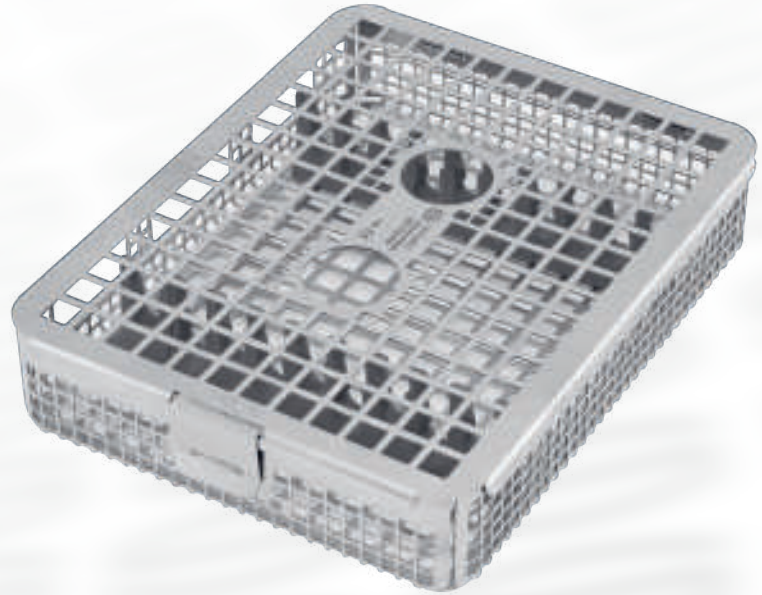

90

Wash Trays



90-716-025

Washing Basket, Series
3, Full-Size, Slim Version,
2pcs. fit 90-626-040

91 INSTRUMENT SETS

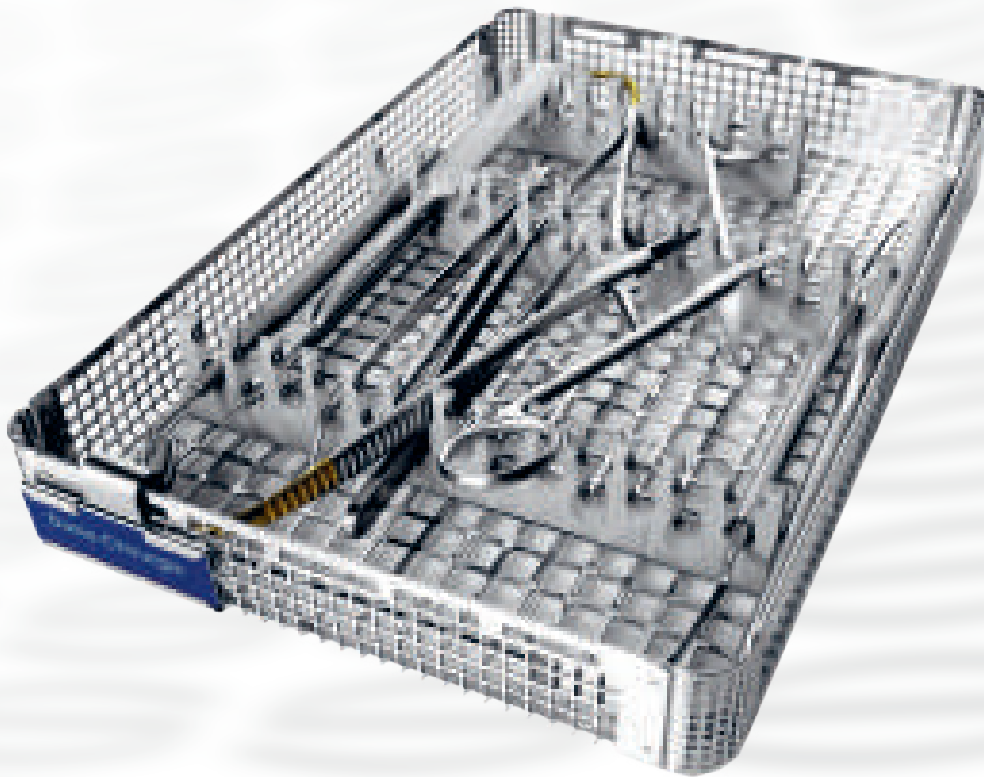

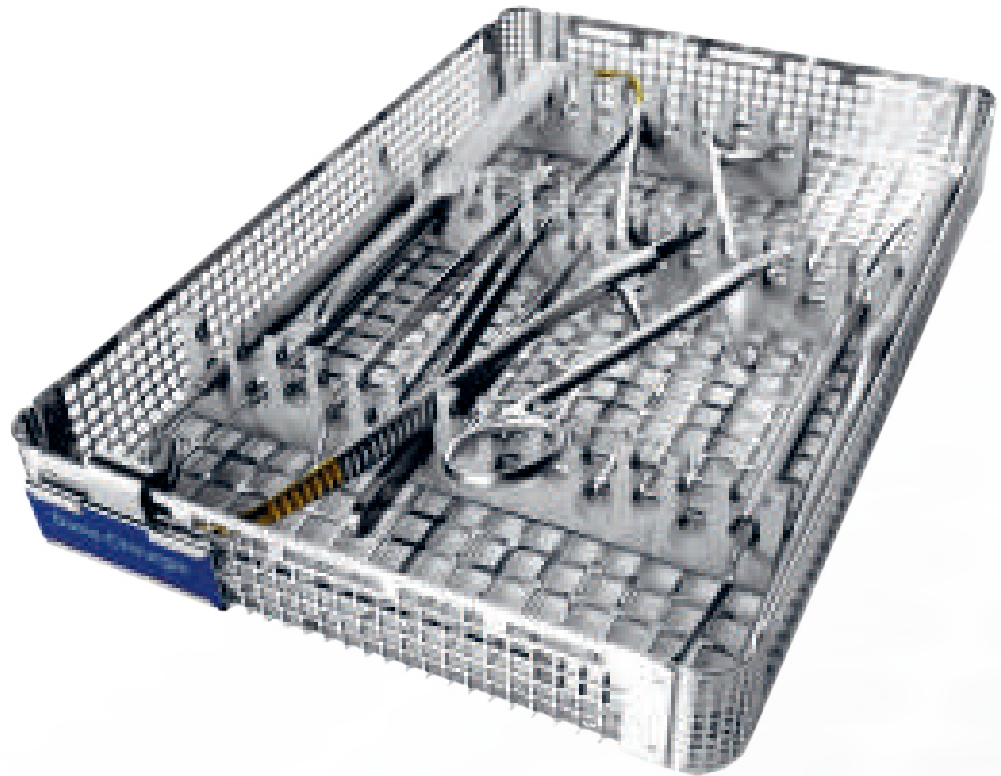

91-100-001

Basic Surgical Set

Constituent Parts:

02-030-030	Scalpel handle, No. 3
03-441-140	JOSEPH, suture-/gum scissors, 14 cm, cvd.
08-235-160	Tissue forceps, 16cm, str., 1x2 t., v.delic.
10-801-150	COLLEGE, tweezers, 15 cm, serrated jaws
20-470-170	LICHTENBERG, needle holder, 17 cm
24-169-005	LANGENBECK, retractor, size 5, 50 x 11mm
27-717-175	Periosteal elevator, 17, 5 cm, d. e., cvd.
27-741-160	WILLIGER, periosteal elevator, 16 cm, cvd.
67-799-020	HEMINGWAY, bone curette, 18 cm, d/e., size 2
84-224-000	Mouth mirror handle, hexagonal, s.s.
86-153-001	Probe, size 1, single-ended, round handle
90-716-001	Wash Basket, Full-Size, MK 3, cross-wise racks



02-030-030



03-441-140



08-235-160



10-801-150



20-470-170



24-169-005



27-717-175



27-741-160



67-799-020



84-224-000



86-153-001



90-716-001

91

Apical Surgery Kit

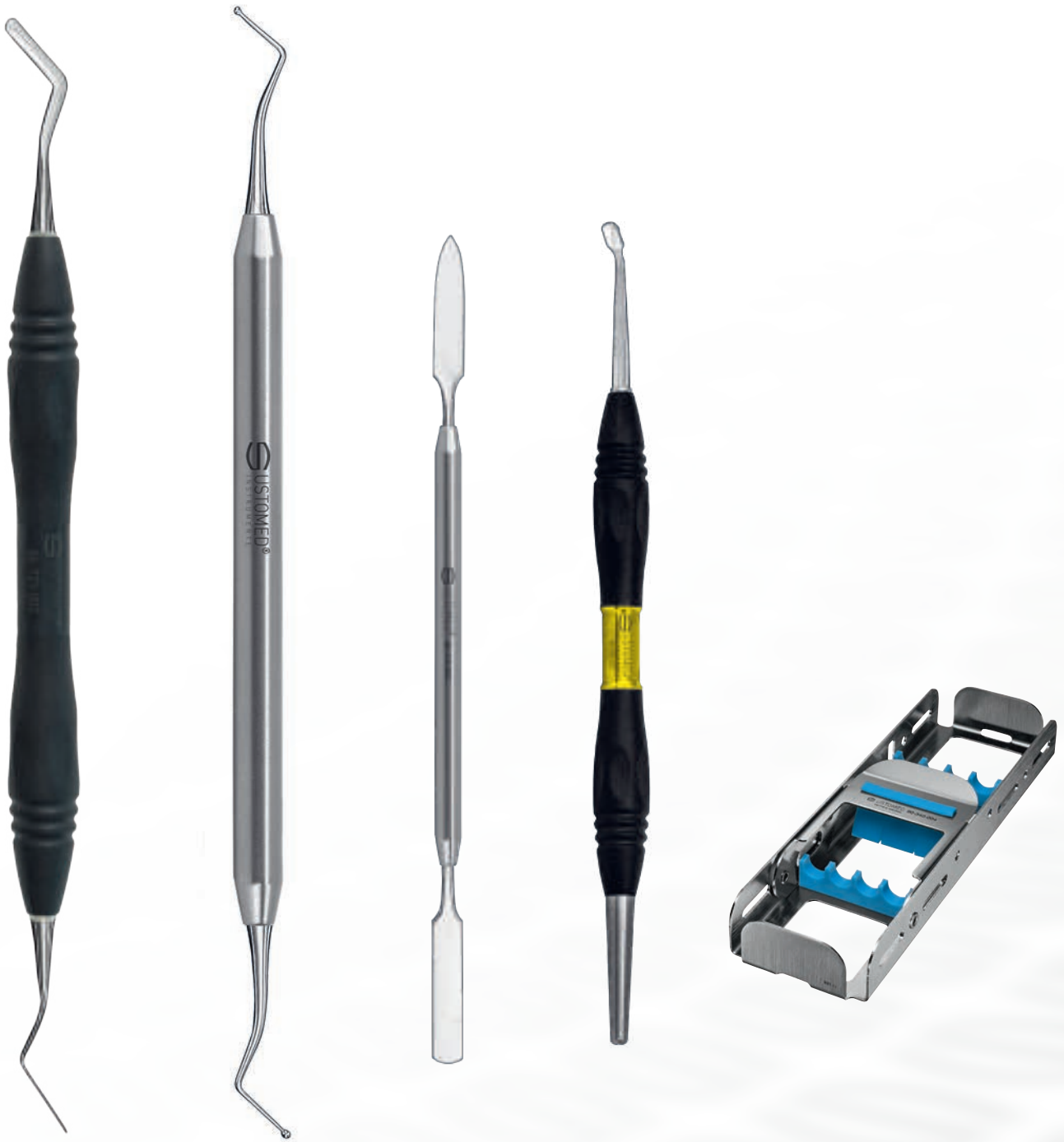

Constituent Parts:

91-101-001

Apical Surgery Kit

- | | |
|-----------------|--|
| 86-721-002 | HEIDEMANN, spatula, flex., sz.2, double-end. |
| 86-521-002 | Plugger, ball shaped, size 2, double-ended |
| 86-350-002 | Cement spatula, size 2, double-ended |
| 84-285-062 P0T3 | Root res. mirror, plane, rhodium, 6x3 mm |
| 90-340-004 | Storing Tray, Quarter-Size, for 4 instruments (Mirror, Probe, Perio Prone, |





Constituent Parts:

91-100-002

Basic Implantology Set

02-030-030	Scalpel Handle, No. 3
03-441-140	JOSEPH, suture-/gum scissors, 14 cm, cvd.
08-235-160	Tissue forceps, 16cm, str., 1x2 t., v.delic.
10-801-150	COLLEGE, tweezers, 15 cm, serrated jaws
20-710-180	BARRAQUER, TC Micro-Needle Holder, 18 cm, straight, round handle
24-169-004	LANGENBECK, retractor, size 4, 40 x 11mm
27-717-175	Periosteal elevator, 17, 5 cm, d. e., cvd.
27-741-160	WILLIGER, periosteal elevator, 16 cm, cvd.
67-799-020	HEMINGWAY, bone curette, 18 cm, d/e., size 2
73-100-065	Needle and Drill sterilizing box, perforated, 65 x 42 x 8 mm
84-224-000	Mouth mirror handle, hexagonal, s.s.
85-695-012	Periodontal probe, CP 12, colour marking
86-153-001	Probe, size 1, single-ended, round handle
90-716-001	Wash Basket, Full-Size, MK 4, cross-wise racks



02-030-030



03-441-140



08-235-160



10-801-150



20-710-180



24-169-004



27-717-175



27-741-160



73-100-065



67-799-020



84-224-000



85-695-012



86-153-001

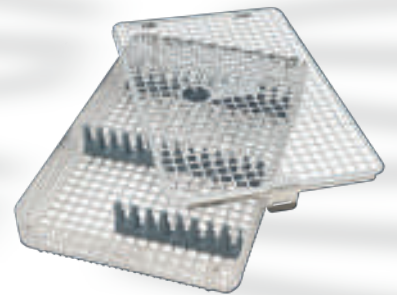

90-716-001



91-100-003

Micro Set Basic

Constituent Parts:

02-038-140	Micro-Scalpel Handle, 14 cm, anatomical shape
05-809-180	Micro-spring handle scrs., 18cm, cvd.round
09-270-180	DE BAKEY, micro atraum. fcps., 18cm, str.
20-710-180	BARRAQUER, TC Micro-Needle Holder, 18 cm, straight, round handle
85-691-015	UNIV.NORTH CAROLINA, period. probe CP15
85-816-170 P0T3	USTOMED, Mod. B, micro raspatory, 17cm
85-818-002 P0T3	KASAJ, tunnelling knife, Micro, 19cm, cvd.
90-716-001	Wash Basket, Full-Size, MK 4, cross-wise racks



02-038-140



05-809-180



09-270-180



20-710-180



85-691-015



85-816-170P0T3



85-818-002P0T3

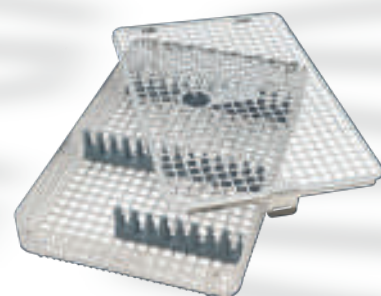

90-716-001



„I am using the I'Motion set for about a year. It is working perfectly with 6/0-7/0 threads. Thanks to it's small head and precise lock, I can work with it gently, furthermore, it is extremely rare to tear the thread, owing to it's rounded, smooth shape. It fits easily into narrow places.

PERFECT CHOICE NOT ONLY FOR PERIODONTAL PLASTIC MICRO- SURGERIES!

Dr. Dávid Botond Hangyási



I appreciate the ergonomic and lightweight design of these instruments providing a precise and

CONTROLLED HANDLING EVEN DURING LONG SURGERIES.

Prof. Dr. Adrian Kasaj, DDS, MSc, PhD

91-180-000

Mucogingival Plastic Surgery Set

05-803-180	I'Motion, Micro-scissors, 18cm, cvd
09-280-180	I'Motion, Micro-forceps, Cooley,
20-753-180	I'Motion, Micro-Needleholder, 18cm, curved, TC Alternativ 20-752-180
02-038-140	Micro-Scalpel Handle, 14 cm, anatomical shape
10-871-160	Suture forceps, 16 cm, with eye tips
85-691-115 P0T3	UNIV.NORTH CAROLINA, period. probe CP15+Probe
85-814-175 P0T3	Papilla elevator, 17, 5cm, Mod. Z
85-818-001 P0T3	KASAJ, tunnelling knife, 20cm, straight
85-818-002 P0T3	KASAJ, tunnelling knife, Micro, 19cm, cvd.
85-818-175 P0T3	Tunneling knife, 19 cm, cvd.
90-716-001	Wash Basket, Full-Size, MK 2, Flexi- Kit



ULTRA-LIGHT MICRO INSTRUMENTS

THE NEW BENCHMARK IN SURGERY



02-038-140



05-803-180



09-280-180



10-871-160



20-753-180
OR
20-752-180



85-691-115P0T3



85-814-175P0T3



85-818-001P0T3



85-818-002P0T3



85-818-175P0T3

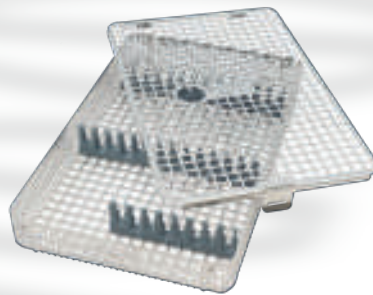

90-716-001



DR. MARCO DEGIDI

Adjunct Professor, Postgraduate Program in Clinic Implantology and Biomaterials, University of Chieti. Adjunct Professor, Postgraduate Master in Clinic Implantology, University of Bologna.

Speaker in many national and international seminars, congresses and courses; many national and international publications.

Active member of AO, EAO, ICOI and SIO.

Private Practice in Bologna, restricted to implant surgery & prosthetic.



MR. GIANLUCA SIGHINOLFI

In 1989 Gianluca was awarded his diploma from the Villaggio del Fanciullo in Bologna, Italy. He immediately began work in an important dental lab in Bologna, later to become a partner.

He has had extensive specialist training and conducted courses both in Italy and internationally. Since 1996 Gianluca has collaborated with Dr. Marco Degidi and Prof. Piattelli on immediate loading research, contributing to the development of new surgery protocols and numerous articles on this subject that have been published in leading international reviews and journals.

Speaker in many national and international seminars, congresses and courses; many national and international publications.

surgery and prosthetics clinic, he knows exactly what he's talking about: perfection in practice means perfection for the patient.

TECHNIQUE

When used at implant level, these frameworks support extremely reliable temporary restorations, and rigidly stabilize immediately loaded implants, resulting in a dramatic improvement in implant success rates.

When used at abutment level with purpose-designed DENTSPLY Implants Manufacturing GmbH components, Intra Oral Welding makes it possible to manufacture extremely high quality and durable prosthetics with enormous precision.

The key to the Intra Oral Welding technique is an ingenious welding unit that was developed by the authors in collaboration with DENTSPLY Implants Manufacturing GmbH; the unit makes it possible to create a framework from a series of welds which join abutments to a connecting titanium bar. This quick and simple procedure is completely risk free for both surgeon and patient. There is absolutely no possibility of excessive heat and the procedure causes no discomfort of any sort to the patient. The very high quality of the weld obtained using this form of electrical resistance welding is comparable and often superior to traditional methods (laser, TIG, etc).

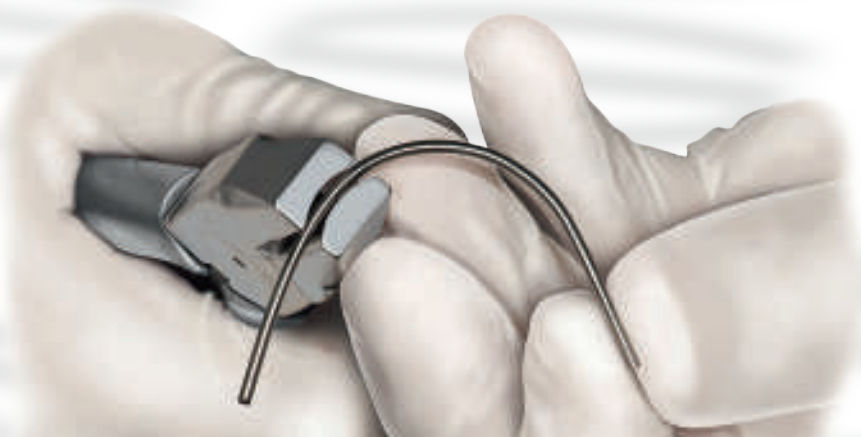

91

WeldOne, IOW-Set

91-110-000

Degidi, WeldOne, IOW-Set

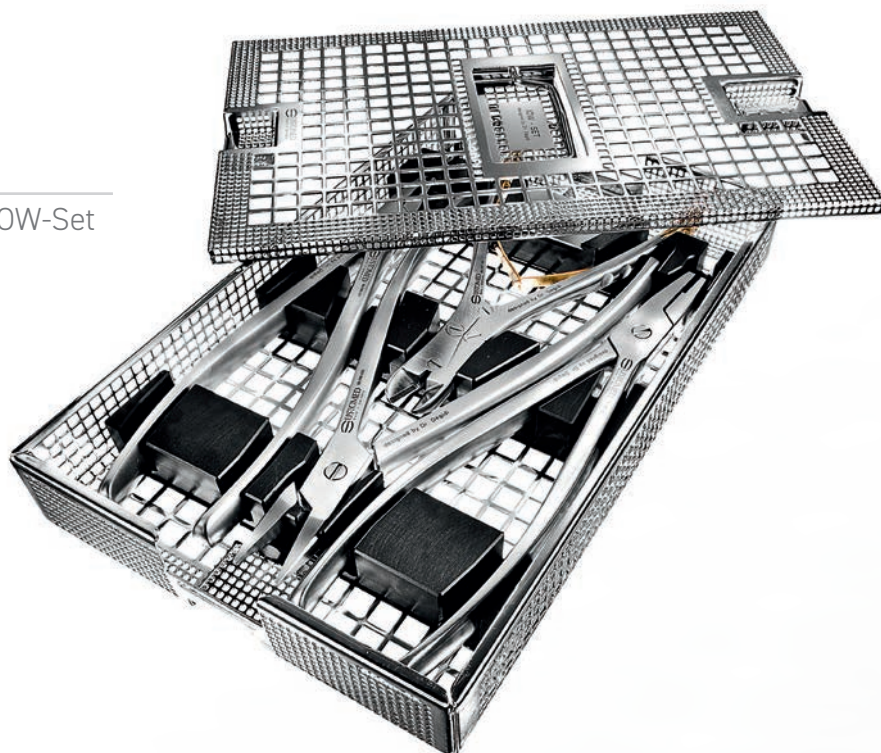

detailed information:

www.dentsplyimplants.com

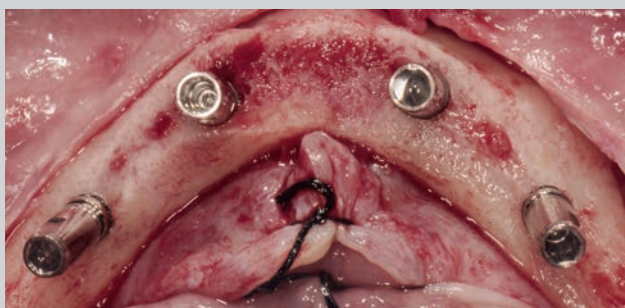

Four implants are placed in the intraforaminal region.

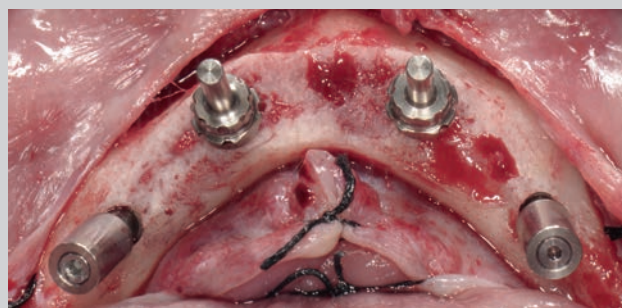

Welding abutments in position.

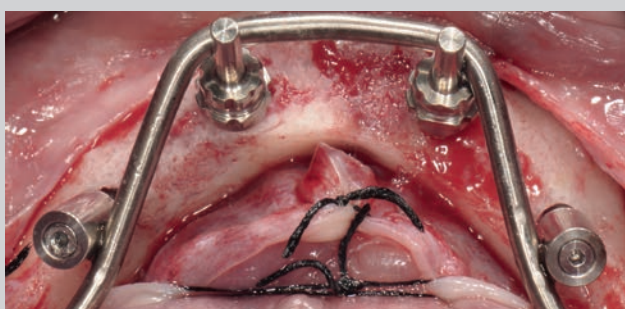

Intra-orally welded framework.



Welded framework removed and reinforced.



Final restoration.

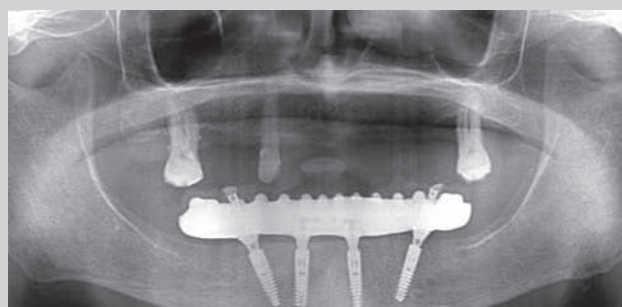

Post-op X-ray.



Sharp Curver
bends the bar into more acute angles
for single abutments.

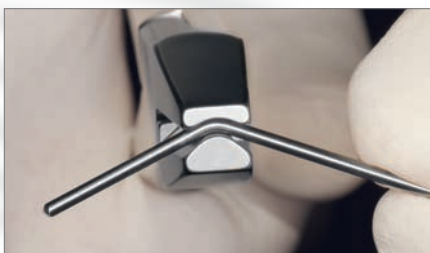

Soft Curver
bends the titanium bar along the curve
of the arch.





Holder
grasps and holds the titanium bar firmly
in place during the welding process.



Cutter with tungsten carbide inserts
easily and efficiently cuts off excess
material.







USTOMED INSTRUMENTE
Ulrich Storz GmbH & Co. KG

Bischof-Sproll-Straße 2
78532 Tuttlingen / Germany

Manufacturer for Surgical and
Dental Instruments

Phone: + 49 (0) 74 61 / 9 65 85 0
Fax: + 49 (0) 74 61 / 9 65 85 65

info@ustomed.de
www.ustomed.de